

Cetetherm

Installation, service and operating instruction Cetetherm AquaFirst

Domestic hot water supply

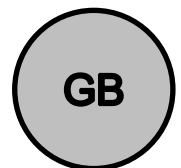

This manual is published by Cetetherm.

Cetetherm can without further notice make changes and improvements to the content in this manual if it is necessary due to printing mistakes, wrong information or changes in the hardware or software. All these types of changes will be included in future release of the manual.

Contents

1	AquaFirst general presentation.....	3
1.1	Product overview AquaFirst	4
2	Operating principle	5
3	Installation.....	6
3.1	Unpacking/Preparation/Mounting	6
3.2	Commissioning	6
3.3	Installation of an AquaFirst Direct (Instantaneous) units	7
3.4	Installation of an AquaFirst Indirect (Semi-Instantaneous) unit	8
3.5	Measure sketch Aqua First 2000 & 4000 Direct version*	9
3.6	Measure sketch Aqua First 2000 & 4000 Indirect version*	10
3.7	Measure sketch Aqua First 6000 & 8000 Direct version*	11
3.8	Measure sketch Aqua First 6000 & 8000 Indirect version*	12
4	Electrical installation.....	13
4.1	Regulator Components	13
4.2	Electrical wiring diagram	14
4.3	Wiring details	15
4.3.1	Power terminal on PCB.....	15
4.3.2	230V 3 points actuator terminals on PCB	15
4.3.3	Low voltage outputs on PCB.....	15
4.3.4	Low voltage inputs (contacts / Sensors) on controller	15
5	User instruction operator control panel Micro 3000	16
5.1	Home screen	17
5.2	Command symbols.....	17
5.3	Setting the time and date	18
5.4	Changing the Date format	18
5.5	Setting the Daylight Saving Time	18
5.6	Saving changes	18
6	End user mode.....	19
6.1	Set the hot water temperature.....	19
6.2	Time programs	19
6.3	Changing time and temperature in a time program.....	20
6.3.1	Special days	20
6.4	Making a Quick temperature change	21
7	Technician menu, total read and write level	22
7.1	Login.....	22
7.2	The technician Main menu	22
7.3	Configuration menu	23
7.4	S1 Menu Secondary Outlet	24
7.5	Thermal Treatment Menu	24
7.6	Safety Function	25
7.7	Eco-Booster Function.....	25
7.8	Fouling function	26
7.9	230V Triac menu	26
7.10	Pumps Menu	27
7.11	Autotest menu	28
7.12	Clear alarm menu	29
8	Service Menu 	30
8.1	Change password for technician level	30
8.2	Login installer	30
8.3	Menu Continue	31
8.4	Operating hours.....	32
8.5	Trending parameters	33
8.6	Display the trend buffer	34
8.7	Point Data.....	34

9	Alarm menu 	35
10	Parameters list	36
11	Factory RESET	37
12	Modbus	38
12.1	Modbus communication	38
12.2	Connecting multiple Micro 3000 control boxes	38
12.3	Change Modbus parameters	39
12.4	Modbus slave communication parameters	40
13	Trouble shooting	41
14	Maintenance and repairs	42
14.1	Open the control box	43
14.2	Change fuses	43
14.3	Pumps' number	44
14.4	Add a recycling pump to an AquaFirst Direct	44
14.5	Add an extra pump	44
14.6	Primary pump wiring	44
14.6.1	Wirings inside pump	44
14.6.2	Pump head setting	45
14.6.3	Operating status	45
14.7	Add an extra sensor	45
14.8	230V Triac output	45
14.9	Relay 1 and 2 contacts	45
14.10	Remote Control contact	46
14.11	Clean plate heat exchangers	47
14.12	Technical data	47
14.13	Spare parts-Aqua First 2000 & 4000	48
14.14	Spare parts Aqua First 6000 & 8000	49
15	Commissioning report	50
16	Declaration of conformity	51
17	Warranty	52
17.1	How to contact Cetetherm	52

1 AquaFirst general presentation

Cetetherm AquaFirst is a compact tap water system product including a heat exchanger, motorised control valve and managed primary and secondary pumps, as per versions. It is equipped with a control box including a dedicated PCB and communicant temperature controller. Piping is made of specially designed brass parts. AquaFirst has been tested hydraulically and electrically at the factory.

The AquaFirst is available in two plate sizes:

- M3H for model FI2000 and FI4000.
- M6M MH/ML for model FI6000 and FI8000.

There are in total 40 models of the AquaFirst, 12 direct and 24 indirect. All types can have single or double pumps.

Option:

- rock wool insulation with cladded aluminium sheet

The AquaFirst must be connected to a primary heating source, like a boiler or a heat exchanger. The secondary side is connected to cold water inlet and to domestic hot water network, see flowcharts for more details.

The tap water module is designed for indoor installation, for example in a plant room. The ambient temperature in the room must be min 0°C and max 40°C, max humidity 85% without condensation.

AquaFirst is **WRAS approved**. This approval demonstrates it is of a suitable quality and standard against the requirements of the UK Water Supply (Water Fittings) Regulations and Water Supply (Water Fittings) (Scotland) Byelaws, provided it is installed and used in accordance with the installation and requirement notes and any other restrictions within the approval. These are available on the WRAS approval directory <https://www.wras.co.uk/search/products/>

1.1 Product overview AquaFirst

AquaFirst 2000 & 4000

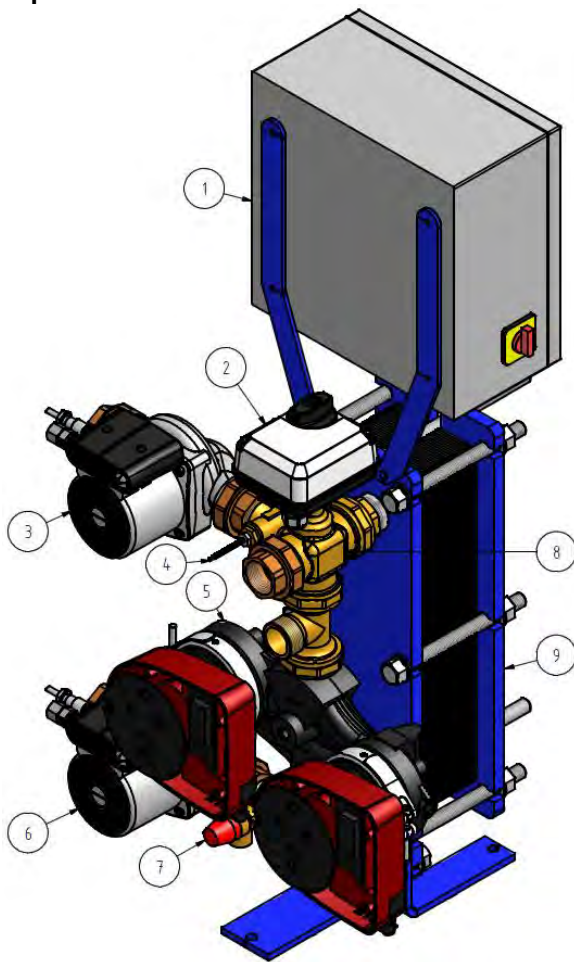

Picture 1

AquaFirst 6000 & 8000

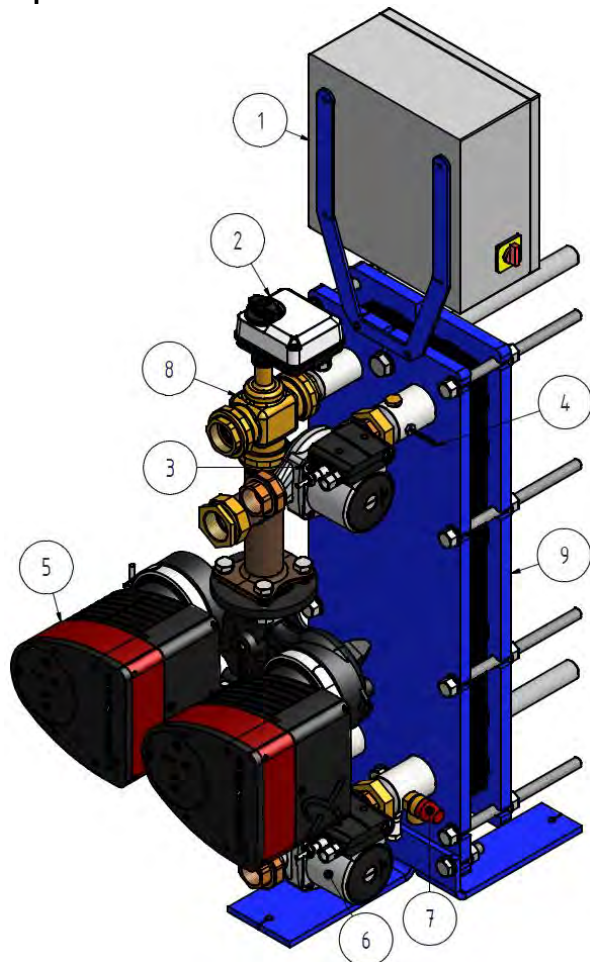

Picture 2

1	Control Box including Micro3000	6	Secondary charging pump
2	Signal actuator	7	Safety valve
3	Secondary charging pump	8	3-port mixing control valve
4	Temperature sensor S1	9	Plates Heat Exchanger with Insulation (optional)
5	Primary single or double pump (as per version)		

2 Operating principle

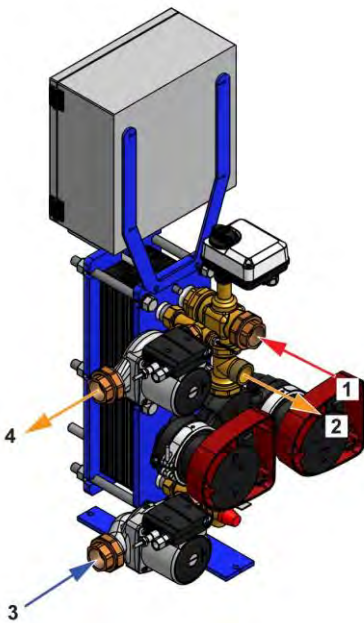

Picture 3

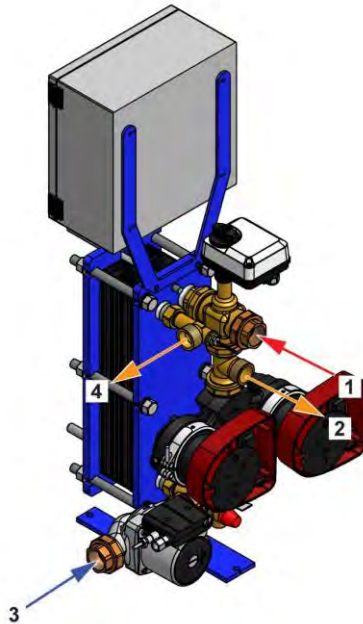

Picture 4

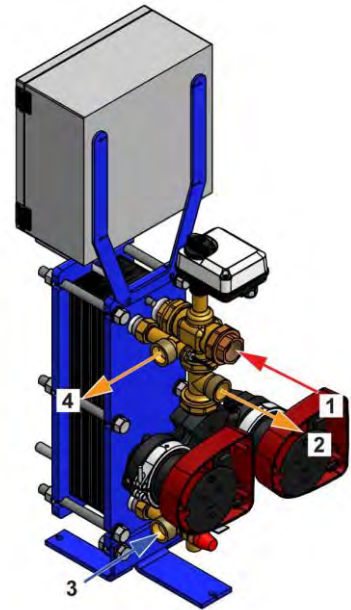

Picture 5

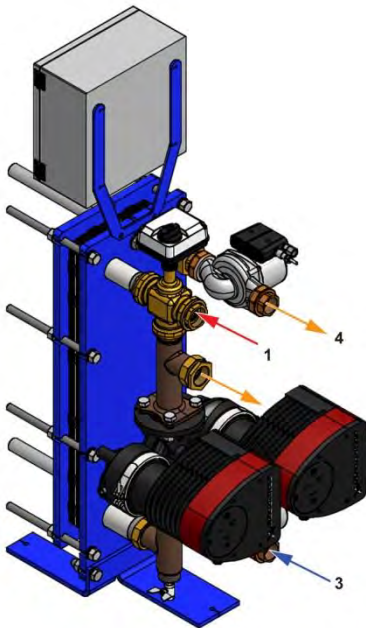

Picture 6

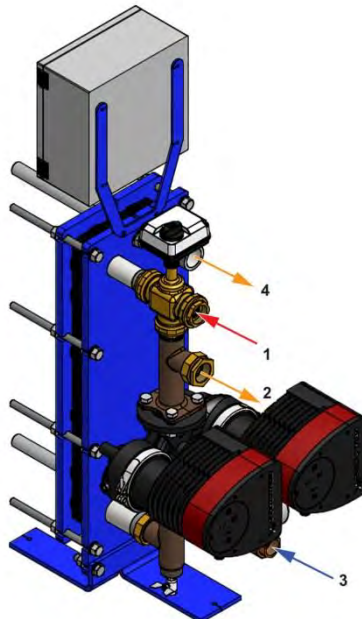

Picture 7

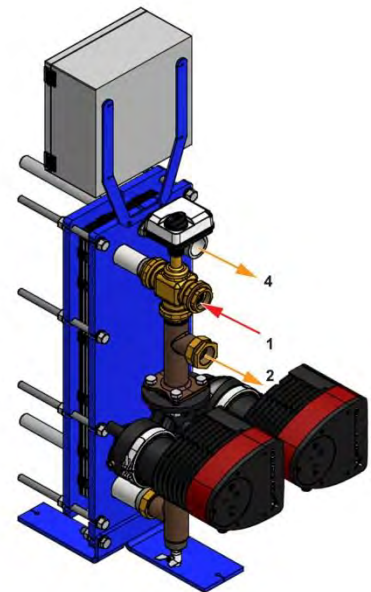

Picture 8

- The primary water enters the 3-port modulating valve (1) and leaves through the fitting (2).
- Cold water enters at bottom part (3) and leaves at the required temperature at high part (4).
- The secondary circuit should be equipped with a recirculation or a charging pump,
- Modules suitable for 230V 1 phase / 50 Hz + Earth,
- Make sure power supply in the field corresponds to the above voltage,
- A fuse protection should be provided on site.
- Relays: Volt Free Contacts (VFCs), 2 Amps maxi, each under 230 V.

3 Installation



The installation work must be carried out by an authorized installation contractor.



The temperature and the pressure of the water are very high. Only qualified technicians are allowed to work with the AquaFirst. Incorrect operation may cause serious personal injury and result in damage to the building.



Minimum pressure/temperature on primary side: 1.0 bar/ 2°C, 1.5 bar / 110°C

Maximum pressure/temperature on primary side :10 bar /110°C

Maximum pressure on secondary side: 10 bar/ 100°C

3.1 Unpacking/Preparation/Mounting

- Rinse the pipes, before connecting them to the tap water module.
Pipe works may contain solid particles that could block or prevent the modulating valve to operate correctly.
- Pipe the primary and the secondary of the module.
- Fill-up both sides progressively with water.
- Purge air at high parts.
- Purge all the pump bodies.
- Switch the power on.
- Check controller setting and enable the required functions.

3.2 Commissioning

Before installation this manual must be read.

The controller has been set at the factory. If any function needs tuning, values can be changed with reference to this manual for parameter setting. Initially, the commissioning process should be carried out with the factory settings.

Fill out the form in chapter [15 Commissioning report](#).

3.3 Installation of an AquaFirst Direct (Instantaneous) units

The tap water modules should be installed according to the following schematics.

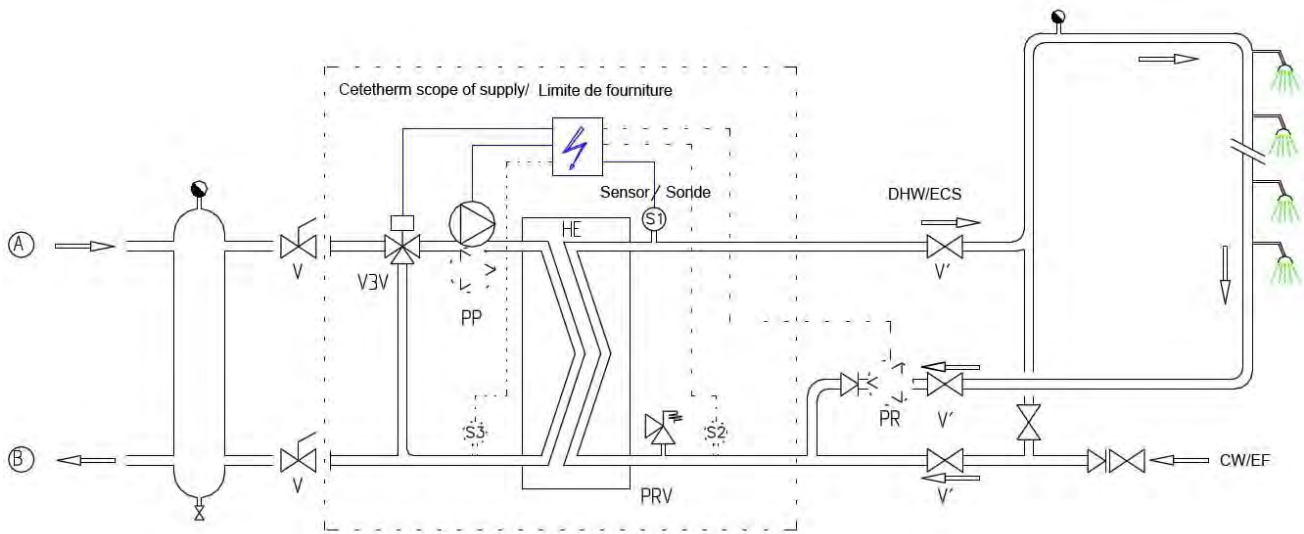

Picture 9

REP	DESIGNATION	REP	DESIGNATION
A	Primary inlet	HE	Heat Exchanger (PHE)
B	Primary Outlet	PP	Primary pump (single/double)
CW	Cold water inlet	PR	Recycling pump (option)
V3V	Mixing 3 port control valve with actuator	V	Manual gate valve
PRV	Pressure relief valve	S1	DHW temperature sensor (master)

The primary water tank limits available generator capacity.

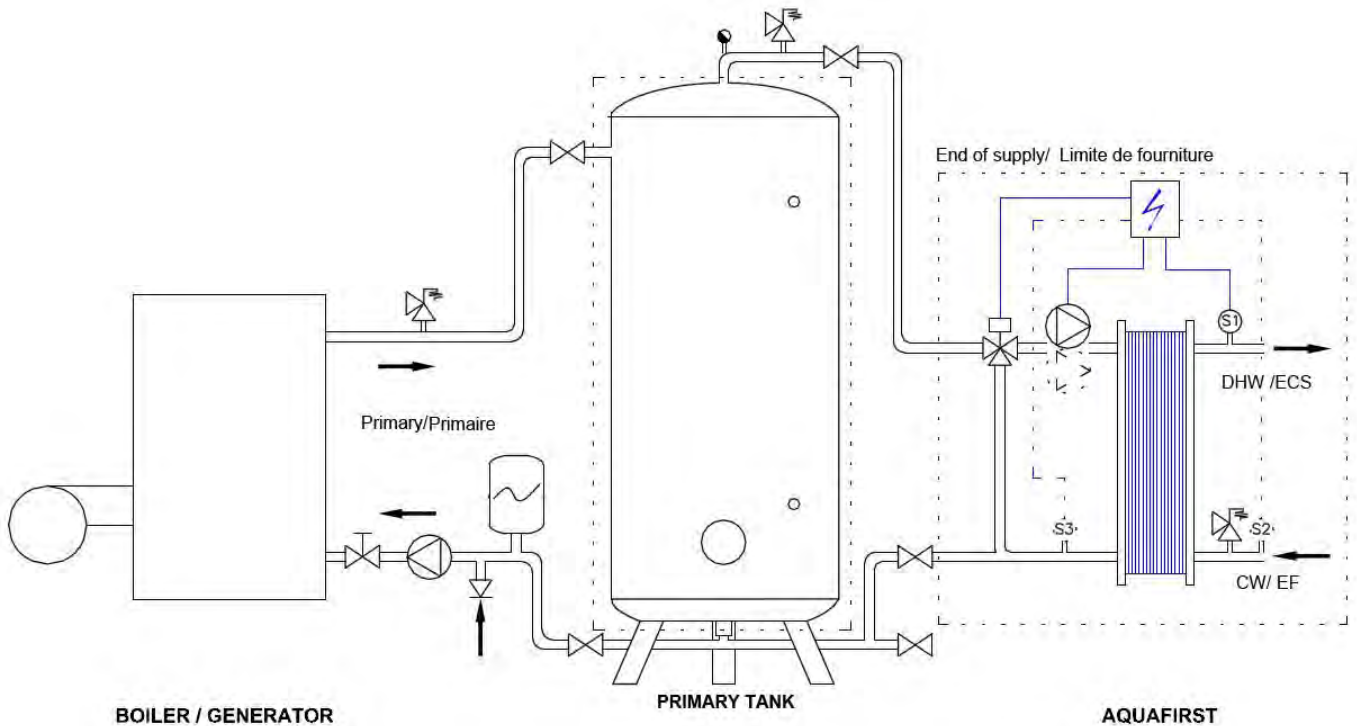

Picture 10

3.4 Installation of an AquaFirst Indirect (Semi-Instantaneous) unit



Recycling flow rate PR must be < 60% PC flow rate.

Protect the storage tank by installing the added safety valve. Pressure gage=tank MAX working pressure and can be different from tap water module's safety valve pressure gauge. The safety valve protects the storage vessel and not the tap water system.

Secondary charging pumps have the following limitations as per water quality:
 pH 6 to 9 and TH<25 French degrees (25°TH) or 14 German degrees (14°dH).

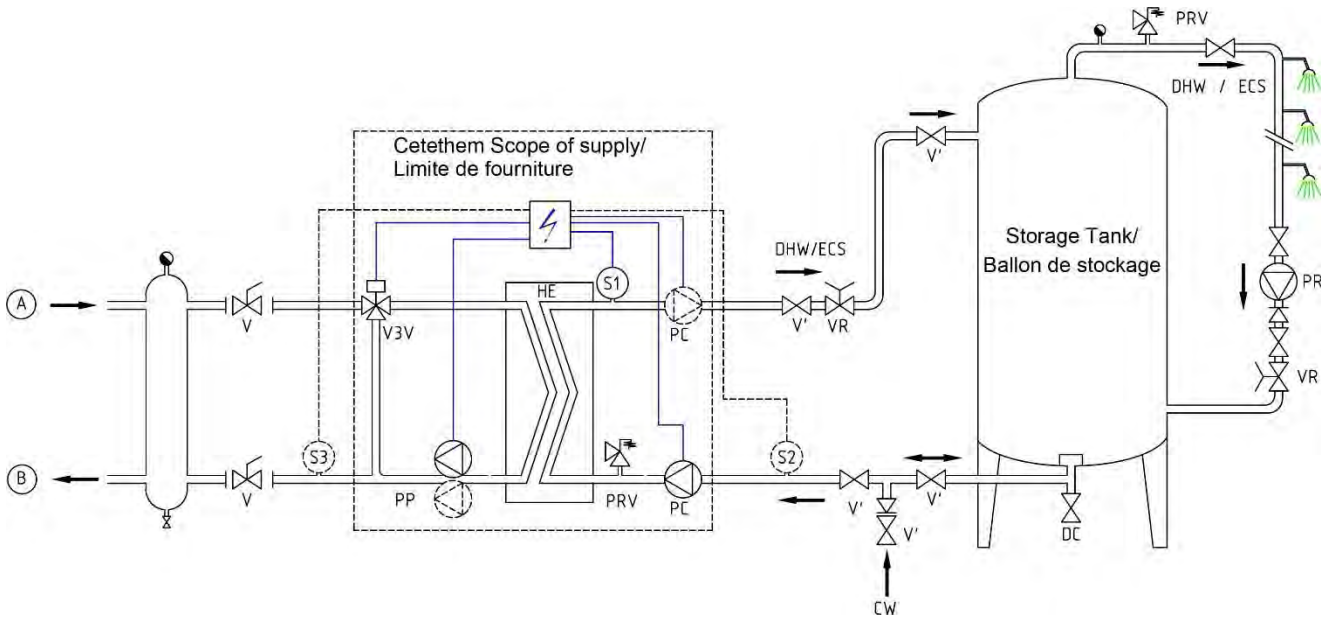

Picture 11

REP DESIGNATION

A	Primary inlet
B	Primary Outlet
VR	Setting valve
CW	Cold water inlet
V3V	Mixing 3 port control valve with actuator
PRV	Pressure relief valve

REP DESIGNATION

HE	Heat Exchanger (PHE)
PP	Primary pump (single/double)
PC	Charging Pump (1 or 2)
PR	Recycling pump (on installation)
V	Manual gate valve
S1	DHW temperature sensor (master)

3.5 Measure sketch Aqua First 2000 & 4000 Direct version*

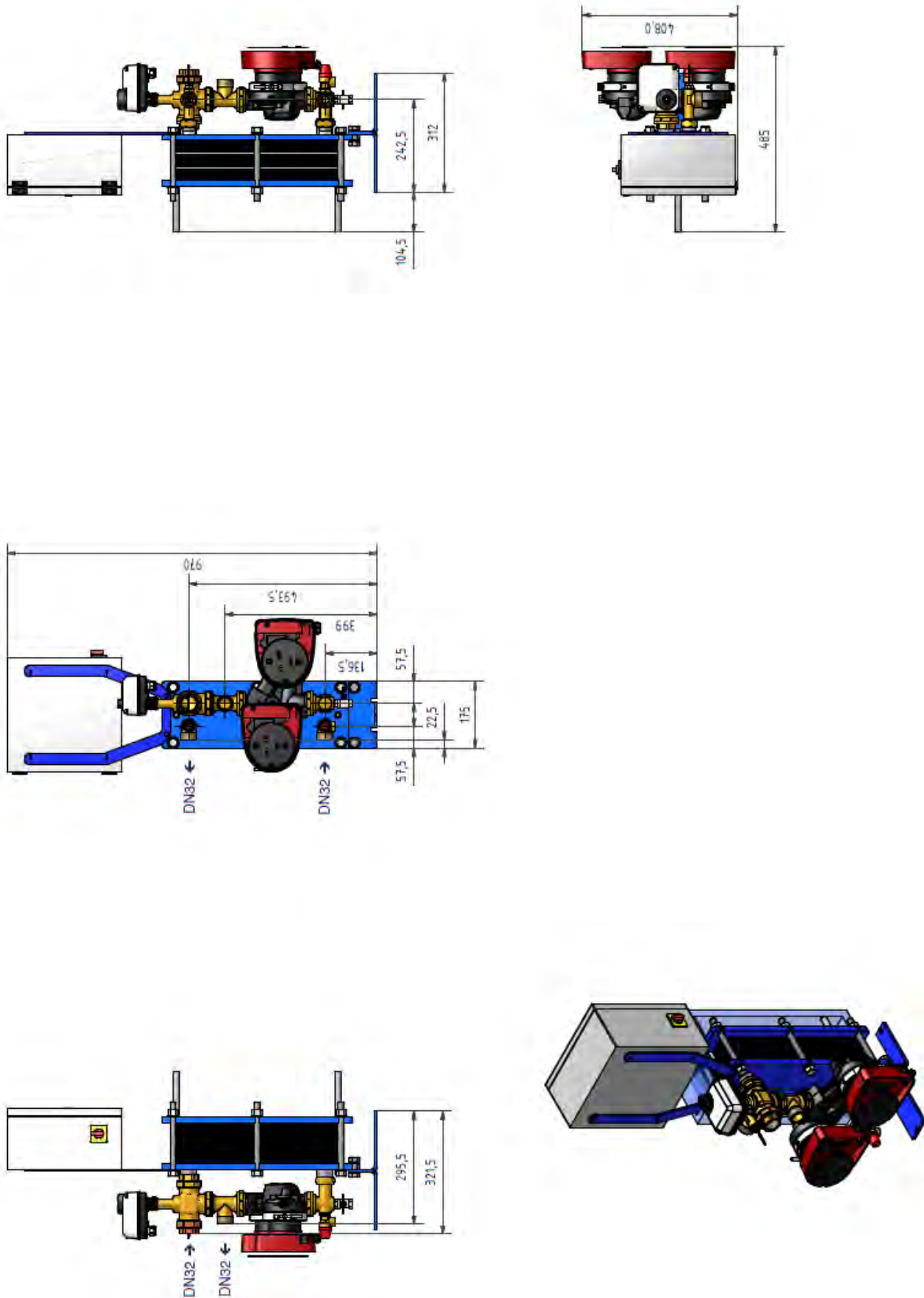

Picture 12

* Pump type, single or double

3.6 Measure sketch Aqua First 2000 & 4000 Indirect version*

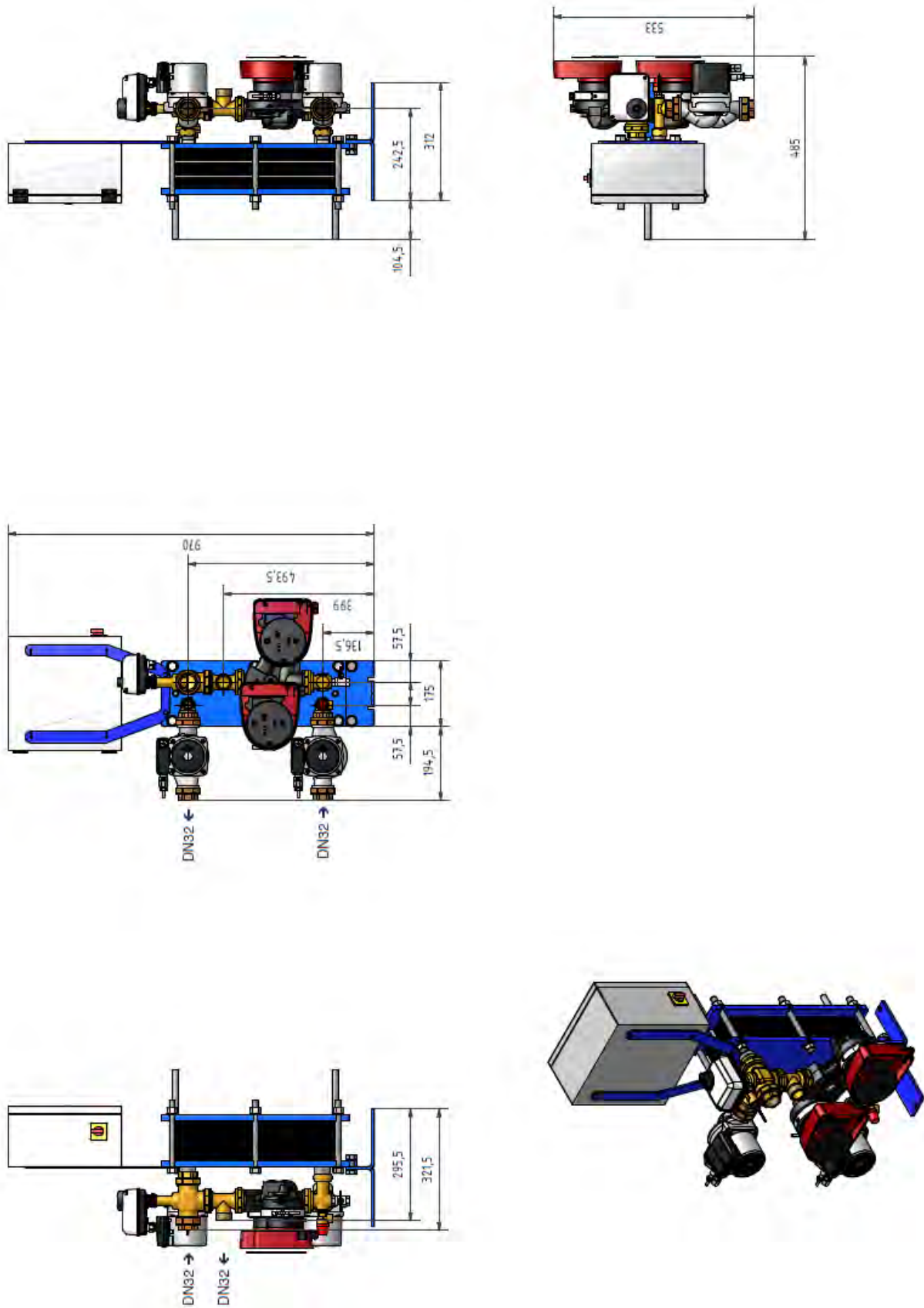

Picture 13
 * Pump type, single or double

3.7 Measure sketch Aqua First 6000 & 8000 Direct version*

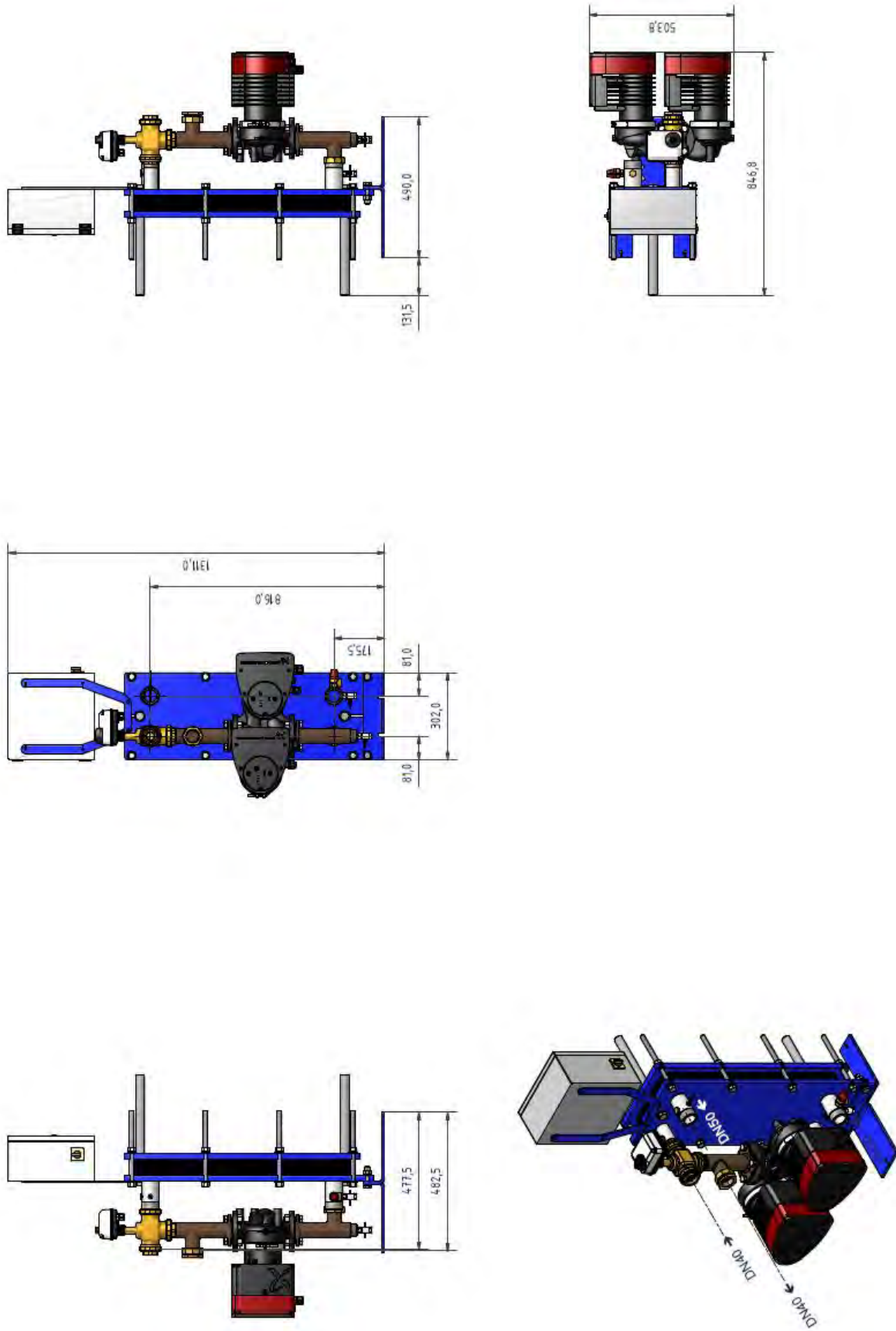

Picture 14
 * Pump type, single or double

3.8 Measure sketch Aqua First 6000 & 8000 Indirect version*

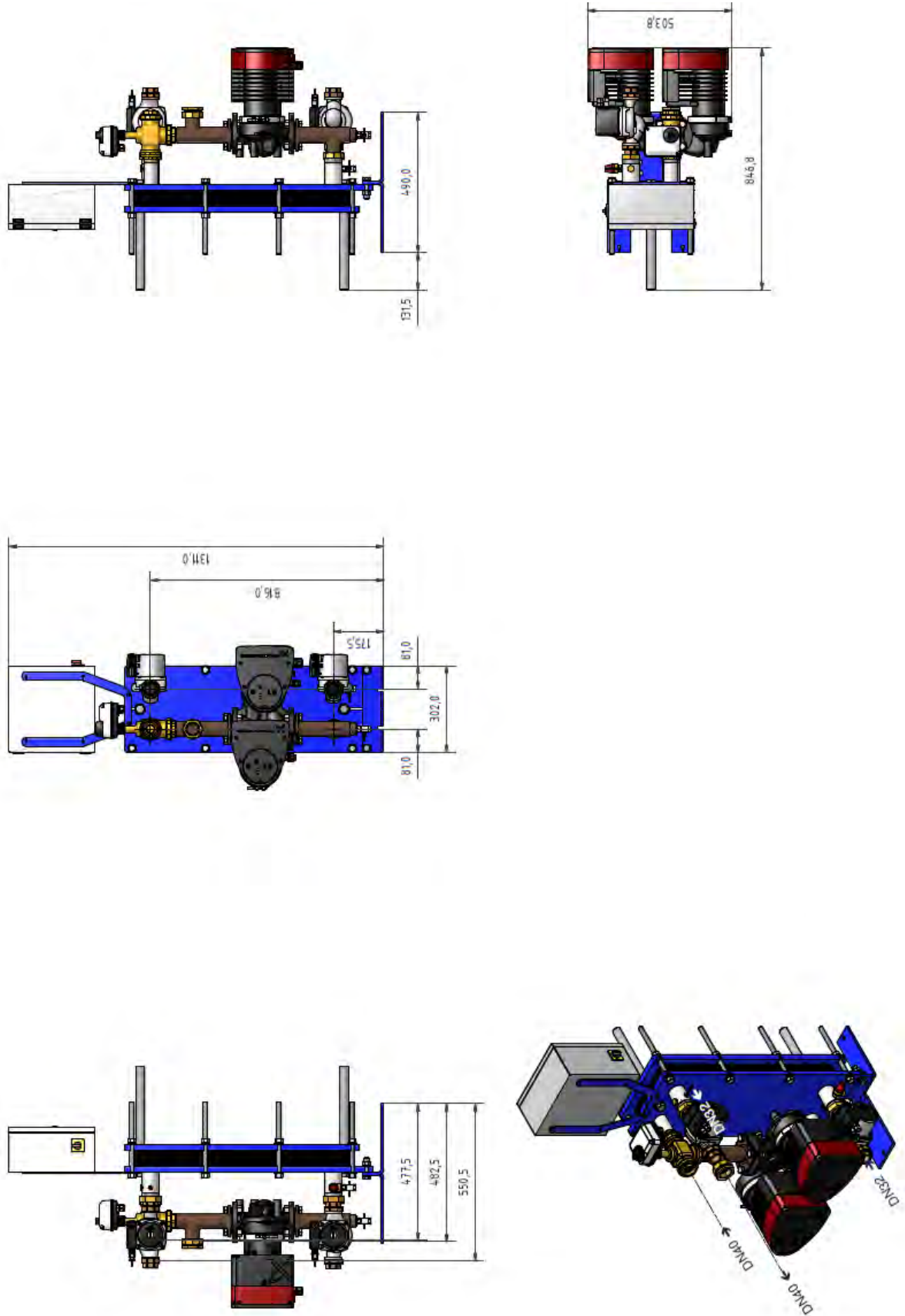

Picture 15
 * Pump type, single or double

4 Electrical installation



Power supply the control box with 230V 50 Hz + Earth, using electric protection in the main electric power box. Micro 3000 box is a secondary electrical control box. Human protections and protection against short circuits and over intensity must be installed in the main electric box.

4.1 Regulator Components



Picture 16

- | | | | |
|---|------------------------|---|-----------------------|
| 1 | Controller, Micro 3000 | 3 | Power Supply |
| 2 | Main switch | 4 | Printed Circuit Board |

4.2 Electrical wiring diagram

NOTE: When the remote-control contact is open, the unit operates normally. If it is closed the unit is in standby.

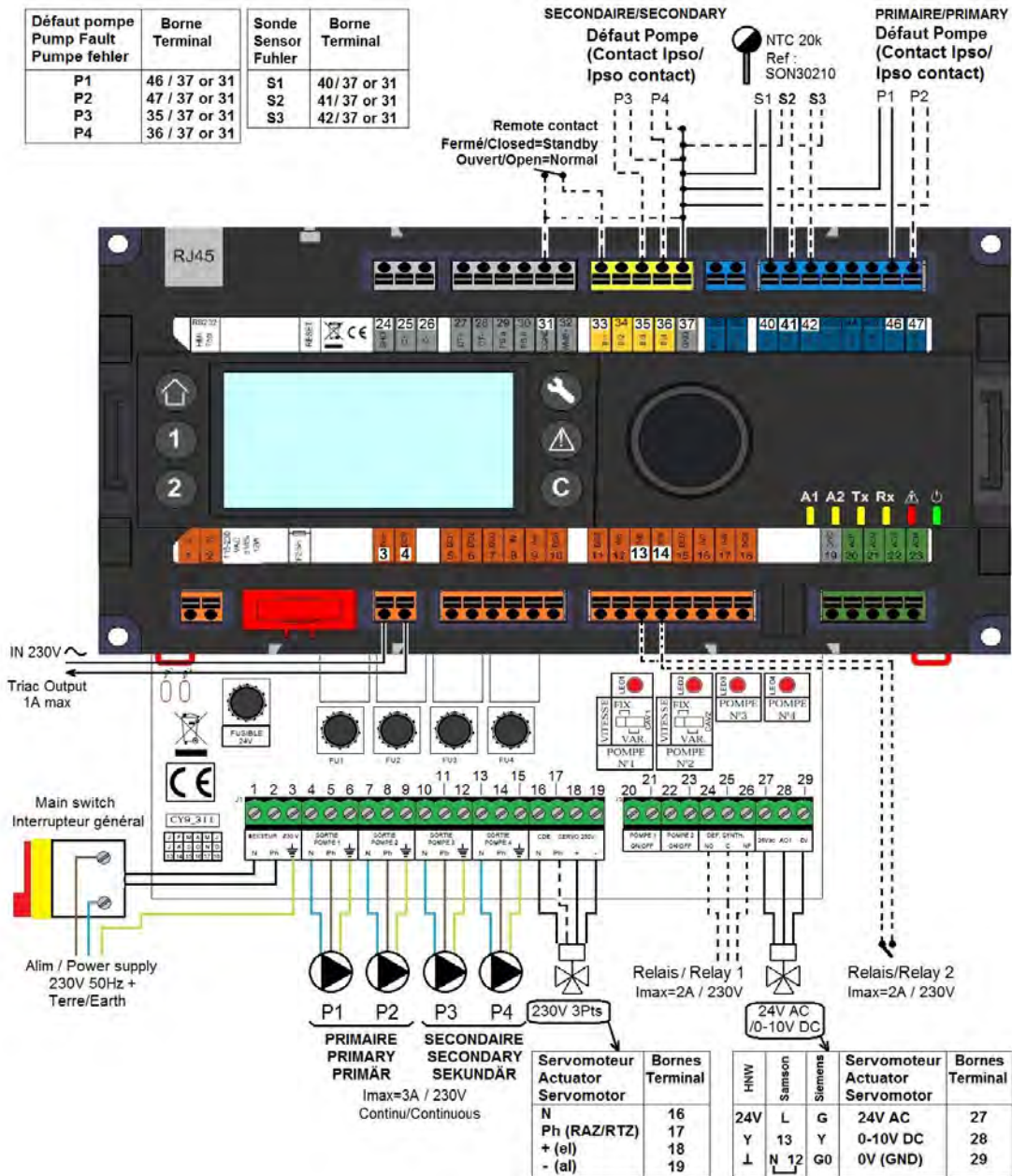

Picture 17



Earth or Ground wiring on the PCB IS MANDATORY. It must be connected to terminal No.3.
Remote contact:

If contact closed, the unit is in standby. If contact open, the unit is operating normally.

4.3 Wiring details

4.3.1 Power terminal on PCB

1	2	3	4	5	6	7	8	9	10	11	12	13	14	15
N	Ph	±	N	Ph	±	N	Ph	±	N	Ph	±	N	Ph	±
230V Main Power supply			Pump 1 (Primary)			Pump 2 (Primary)			Pump 3 (Secondary)			Pump 4 (Secondary)		

Control box power supply: 230V 50Hz + Ground terminals 1,2 and 3.
Terminals 4 to 15 are dedicated to P1, P2, P3, P4 230V power supply.



Do not exceed 3A per pump.

4.3.2 230V 3 points actuator terminals on PCB

16	17	18	19
N	Ph	+	-
230V 3 points actuator			

Opening of the actuator is made sending 230V pulses between terminals 16 (N) and 18 (+).
Closing of the actuator is made sending 230V pulses between terminals 16 (N) and 19 (-).

Terminal 17 (permanent Phase) can be used with return to zero (RTZ) actuators.



3 points 230V and 0-10V signals (or pulses) are sent continuously even if they are not wired.

4.3.3 Low voltage outputs on PCB

20	21	22	23	24	25	26	27	28	29
0V	S/S	0V	S/S	NO	C	NC	24Vac	AO1 (0-10V)	0V
Pump 1 Start / Stop N/A		Pump 2 Start / Stop N/A		Relay 1 contact NO or NC to choose			0-10V DC actuator, 24V AC 5VA power supplied 0V is common on both signals		

4.3.4 Low voltage inputs (contacts / Sensors) on controller

31	33	35	36	37	40	41	42	46	47
GND	Bi1	Ips0 P3	Ips0 P4	GND	U11 S1	U12 S2	U13 S3	Ips0 P1	Ips0 P2
Common	Remote Contact*	Secondary pump(s) default input contact(s)*		Common	Temperature sensor(s) input(s)*			Secondary pump(s) default input contact(s)*	



*For each of these inputs / outputs, the second wire must be connected to the common terminal 37 or 31 as per available space.
There is no polarity on all contacts and temperature sensors.



Temperature sensors' inputs except S1 are already wired. To add a temperature sensor, remove existing wire from the terminal and isolate its end. Connect the sensor's wire instead and its second wire to common terminal, 31 or 37.

5 User instruction operator control panel Micro 3000



Picture 18

Button	Function
	Rotary button for scrolling through the menus. Access sub-menus and change settings by pressing it. To activate the line or change a highlighted value, simply press the wheel. Works like an Enter key.
	Press to exit a level and return to the previous menu/parameter. Works like an ESC key.
	Press to access the maintenance / monitoring menu. NOTE: Requires a password.
	Press to go to the Home screen, Main Menu
	Press to access the Alarm Menu.
	Not used
	Not used
	Relay 1 activated. By default set to General Default. The parameter is set in the Configuration menu.
	Relay 2 activated. By default set to High temp Alarm. The parameter is set in the Configuration menu.
	Active data transmission
	Active data reception
	Alarm indicator
	The Control box is switched on.

5.1 Home screen

When starting up the Micro 3000 controller the Home Screen menu displays on the screen.

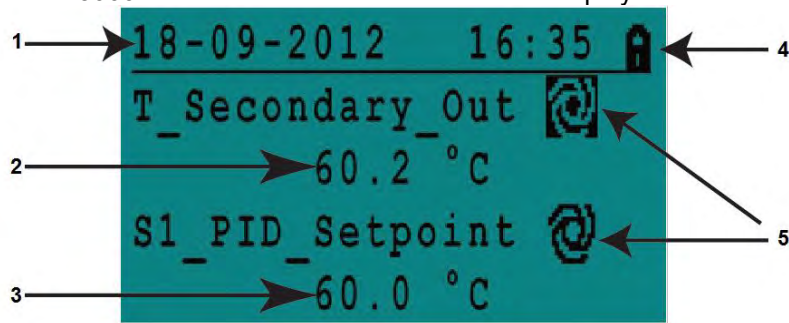

Picture 19

- | | | | |
|---|-----------------|---|---|
| 1 | Date / hour | 4 | Access level:
Locked=restricted
Key= total (3333) |
| 2 | DHW temperature | 5 | Command symbols |
| 3 | DHW Set point | | |

The controller has password protection, allowing accesses to different menus.

- End user level- requires no login. Marked with a locker in the upper right corner.
- Technician level- access to all menus requires login. Marked with a key in the upper right corner.

NOTE: if there is an ongoing alarm when starting up the AquaFirst, an alarm text will be displayed on the screen. Press the House button to enter the Home screen.

5.2 Command symbols



Auto

Datapoint is in automatic operation and can be switched into manual operation.



Manual

Datapoint in manual operation and can be switched into automatic operation.



Today function

Datapoint value can be overridden for a particular time period within the next 24 hours. Datapoint must have a daily time program assigned.



Time Program

Datapoint has a daily time program assigned. Daily time program can be selected and edited.



Edit

Item (datapoint, time program etc.) can be edited.



Add

Item (datapoint, time program etc.) can be added to a list e.g. datapoint can be put to a list of trended datapoints.



Deleted

Item can be deleted



Enable/disable

- Checked: item is enabled
- Unchecked: item is disabled

5.3 Setting the time and date

1. Turn the wheel anticlockwise to highlight the line with time and date at the top of the screen. Press the wheel to enter the Date/Time menu.

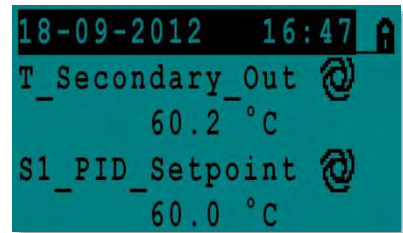

2. Press the wheel to change the first variable, the year.
3. When the year flashes, increase or reduce the set value by rotating the wheel. Once the right value is displayed, press the wheel to confirm the setting. Next parameter to change starts to flash.
4. Proceed in the same way to set the month, date and time (hour: minute).

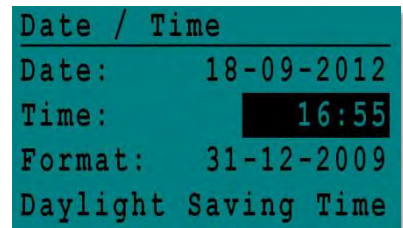
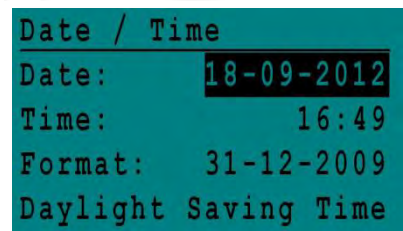

5.4 Changing the Date format

In the Date/Time menu the date format can be changed.

Choose between the following formats:

- yyyy-mm-dd
- mm-dd-yyyy
- **dd-mm-yyyy**
- **dd.mm.yyyy**
- **dd/mm/yyyy**

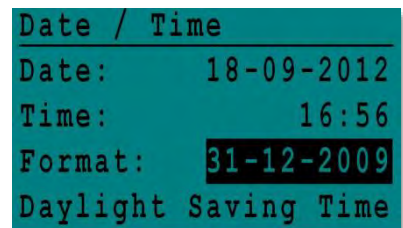

5.5 Setting the Daylight Saving Time

Summer time

Changing between summer/winter time can be automatic or turned off. You can also define the dates for changes if they are altered.

The default settings for summertime is:
 Last Sunday in March to last Sunday in October.

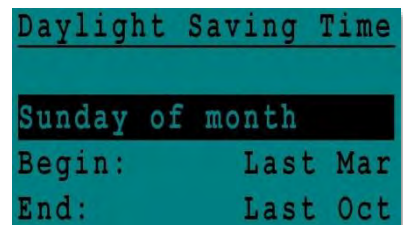

5.6 Saving changes

Once a value has been changed and confirmed by pressing the wheel, the corresponding change will be immediately updated.

Press the or to return to the home screen.

6 End user mode

The following changes can be done in end user mode:

- Settings which are identical/different for each day of the week at defined times
- Normal temperature(s)
- Lower temperature(s)
- Special period of defined duration during the current year
- One time temperature change at a specific time.

6.1 Set the hot water temperature

Please set a hot water production temperature in line with current national legislation and recommendations (UTD, Standards EN, ISO etc.)

All countries have different rules for how hot or cold tap water should be.

Cetetherm recommends the hot water temperature is at least 55°C and a hot water recirculation not less than 50°C.

At a temperature below 50°C there is a risk of bacterial growth.

Note that at temperatures above 60°C the risk of scalding increases.

Set points above 63°C result in an increased risk of precipitation of lime scaling on the surfaces of the heat exchanger.

6.2 Time programs

The time programs used in AquaFirst are adjusted the same way.

Time programs:

- SP_T_Sec_Outlet, to be found in the menu *S1 Menu Secondary Outlet*. It is to set the DHW temperature
- ThTr_Activated to be found in *Thermal Treatment Menu*, to activate a thermal treatment (1 sensor mode).
- Multi_P to be found in *230V Triac menu*, to activate the 230V power output on the controller

The time program has two different temperature modes, week-temperature or weekend-temperature.

Define for each day of the week which mode to use.

By default has the weekend-temperature mode the same settings as the week-temperature mode.

It is even possible to customize the temperature programs with special dates (holidays periods or free days).

Each temperature mode can have several different times set per day. For each time a different temperature can be selected that are then in effect until the next time occurs. If only one time is set, the program will run with the selected temperature.

6.3 Changing time and temperature in a time program

By default, the DHW set point SP_T_Sec_Outlet, set to 60°C by default, at any time, all the days of the week. Add extra temperature set points at different times of the day. These changes will be reported to all days with the time program week, excluding the time program; weekend.

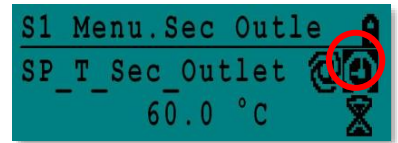

1. Use the wheel and mark the clock logo. Press the wheel.

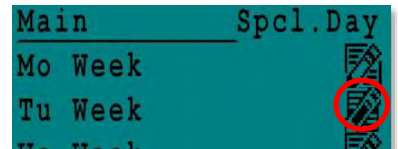

2. Mark the day you want to change. Press the wheel.



Now you can choose to:

- a) Change a time or temperature.
 Mark the line and press the wheel. Change the value by turning the wheel.
 Confirm the new setting by pressing the .
- b) Add a new time or set point; choose .
- c) To delete a time or set point; choose; .

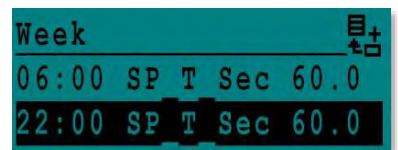
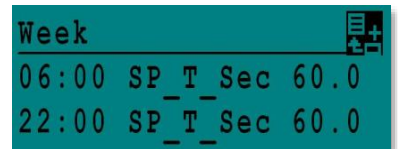

In this example the set point is 60°C at 22h00.

You can choose to reduce the temperature during the night, in this example the night temperature is set to 55°C.



6.3.1 Special days

Exception days, so called special days, can be defined. The calendar in the controller controls the exceptions that can be selected in the Time program. Exception days override the weekly schedule.

In the Main screen menu, mark 'Spcl.Days' and press the wheel.

Choose between:

- Annual - holiday periods where you have to specify beginning date, end date and DHW set point. This mode is applicable to schools, offices and so on.
- Bank Holiday - special days during the year where set points can be different ex: Christmas, New Year.
- Daily programs - particular days where you want to change the temperature set point.

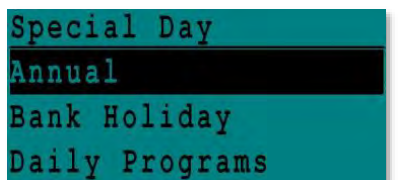

6.4 Making a Quick temperature change

You can quickly define a “one time” temperature change, a period of the day with a different setting. When the change period has expired, the temperature set point goes back to standard time schedule program.

1. In the home-screen, mark the hourglass icon and choose it, by pressing the wheel.

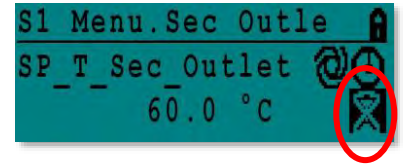

2. Define the starting and ending time, and the temperature set point value.

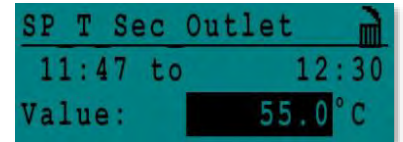

7 Technician menu, total read and write level

In the technician menu you can:

- make settings for the secondary outlet temperature
- enable/disable functions like Eco, booster, thermal treatment
- enable/disable the fouling function (option)
- start an auto test
- clear alarm.

You need to be logged in to:

- see all submenus and change pre-set values
- have full read and write access in the technician menu

7.1 Login

1. Mark the lock  in the upper right corner of the screen and press the wheel.
2. Enter: 3333, to access the technician level.

NOTE: You will be automatically logout after ten minutes if no data has been entered.

7.2 The technician Main menu

To enter the Main menu you press the  key.

The grey marked parameters or menus are not available in the AquaFirst application. Their value does not have any impact on the AquaFirst.

Main Menu		
T_Secondary_Out	<i>Read Only</i>	Measured temperature DHW
S1_PID_Setpoint	<i>Read Only</i>	DHW temperature setpoint
T_Secondary_Inlet	<i>Read Only</i>	N/A
T_Primary_Outlet	<i>Read Only</i>	The temperature measured by S3 (option)
T_Primary_Inlet	<i>Read Only</i>	N/A
T_Recovery1	<i>Read Only</i>	N/A
T_Recovery2	<i>Read Only</i>	N/A
T_Outdoor	<i>Read Only</i>	N/A
Configuration	<i>Sub Menu</i>	See 7.3 Configuration menu
S1 Menu Sec.Outlet	<i>Sub Menu</i>	See 7.4 S1 Menu Secondary Outlet
S2 Menu Sec.Inlet	<i>Sub Menu</i>	N/A
Delta T (S3-S2)	<i>Sub Menu</i>	N/A
S4 Menu Prim Inlet	<i>Sub Menu</i>	N/A
S5 Menu Outdoor T	<i>Sub Menu</i>	N/A
Thermal Treatment	<i>Sub Menu</i>	See 7.5 Thermal Treatment Menu
SAFETY Function	<i>Sub Menu</i>	See 7.6 Safety Function
Eco Booster Fcts	<i>Sub Menu</i>	See 7.7 Eco-Booster Function
Fouling Function	<i>Sub Menu</i>	See 7.8 Fouling function
Pumps Menu	<i>Sub Menu</i>	See 7.10 Pumps Menu
Solar Menu	<i>Sub Menu</i>	N/A
Aquaprot_Heating	<i>N/A</i>	N/A
230V Triac Menu	<i>Sub Menu</i>	See 7.9 230V Triac menu
Auto Test	<i>Sub Menu</i>	See 7.11 Autotest menu
Clear Alarm(s)	<i>Sub Menu</i>	See 7.12 Clear alarm menu

7.3 Configuration menu

NOTE: After resetting the controller, this sub menu should be accessed to configure pumps' number.

Parameter	Factory Setting	Optional setting	Description
Type 0= First 1=Eff	0	0= AquaFirst 1= AquaEff	Set to 0
S5 Active heating	0	0 Disables / 1 Enables heat curve	Set to 0
Cooling Mode AO1	0	0=Heating/ 1=Cooling mode	Set to 0
P12 Nbr of Pumps	0	0/1/2	Primary pump(s) number
MinSpeedP1P2	40	10 >100	N/A
P34 Nbr of Pumps	0	0/1/2	Secondary pump(s) number
Modbus Factor	1	1/10/100	To set displayed decimals on Modbus values. 1=integer value, eg:58°C 10=1 decimal, e.g. 583/10=58,3°C 100=2 decimals, e.g. 5836/100=58,36°C
Relay 1 function*)	1	0..7	0=No action 1=General Default (GD) 2=High temp Alarm (HA) 3=Eco function (E) 4=Booster function (B) 5=Thermal Treatment (TT) 6=Pump Fault (PF) 7=Tank loaded (TL)**. **Requires sensor S2.
Relay 2 function*)	2	0..7	
Renewable Config	Keep 0	N/A	N/A
APilot rev 0=Off 1=On	Keep 0	N/A	N/A
SP distrib 0=I 1=E	0	N/A	N/A
SW AL Version	xx	N/A	Firmware Version

*) Both relay 1 and 2 are programmable.

7.4 S1 Menu Secondary Outlet

Parameter	Factory Default Setting	Optional setting	Description
SP_T_Sec_Outlet 	60°C	DHW Setpoint	Change setpoint value in clock program
Delta T S1 HiAlm	10°C	0-50	High Temperature Alarm if Ts1 SP_T_Sec_Outlet+Delta Ts1 HiAlm
High T Alarm Delay	1 min	0-30	High temp alarm is effective after this temporisation
High Alarm Auto Reset	0	0/1	0=MANUAL alarm clear / 1=AUTO alarm clear
High_Alm_Reset	Off	Off/On	Put ON to clear an high temp alarm, then put Off
P_Band AquaFirst	40	0<P<200°C	↑P to be less reactive
	(-200 to 200)	Negative values in cooling	↓P to be more reactive (be careful of "pumping" effect)
I_Time AquaFirst	15	0-200 sec	↑P to be less reactive
			↓P to be more reactive (be careful of "pumping" effect)
D_Time AquaFirst	2 sec	0-200 sec	
P_Band AquaEff	80	0<P<200°C	N/A
	(-200 to 200)	Negative values in cooling	
I_Time AquaFirst	15	0-200 sec	N/A
D_Time AquaFirst	2 sec	0-200 sec	N/A

7.5 Thermal Treatment Menu

The function Thermal Treatment is disabled by default.

Activate it by setting TrTh_Activated to ON.

The clock program logically activates it automatically or not.

The thermal treatment starts when the thermal treatment is switch on inside the clock program, and ends at the end of the thermal treatment duration (ThermTr Duration) or at the end of the authorized period, when thermal treatment is OFF in the clock program.

The user has to define a one (1) sensor mode - fixed duration as per Therm.Tr duration parameter.

Parameter	Factory Default Setting	Optional setting	Description
ThTr_Setpoint	70°C		Usual value
ThTr_Activated 	Off	Off/On	Define the thermal treatment authorized period
Sensor_Nbr NS 0=Auto/1/2S	1	Auto/1 sensor/2 sensors	Use 1 sensor (set on 1)
ThTr Duration	1 min	1-240 min (4 hours max)	Adjust value according to the installation + buffer vessel capacity
Fixed duration (1 sensor)	1	0/1	Set to 1
TT Max try time	1 min	1-240 min (4 hours max)	Not used
DeltaT S1S2 ThTr	7°C	1 - 20°C	Not used
Inhibition time	30 min	0-180 (0 à 3 hours)	High temp alarm inhibition time after thermal treatment

7.6 Safety Function

This function activates the four pumps' power relays at the same time without considering ipsothermic contacts' inputs.

NOTE: This function can be enabled from base access level.

Parameter	Factory Default Setting	Optional Setting
SAFETY_Speed	75%	Not used
SAFETY_FCT	Off	Off/On



In case of high temperature alarm on S1, the primary pumps are stopped, even if the function is activated.

7.7 Eco-Booster Function

One or both functions can be activated at the same time.

- ECO:** When control valve is sufficiently closed (Valve Hysteresis) during a sufficient long time (ECO delay), primary pump switches off and primary mixing valve close down. The system is switch ON when S1 temperature has gone down more than the set value of "Eco Hysteresis".
If secondary pumps are connected (SS/DS/DD series) they are still in operation during the Eco function.
- Booster:** If DHW temperature is dropping down faster than "Booster Gradient", the second primary pump (if existing) is energized, to increase the primary flow rate. Function stops when DHW temperature is back to the setpoint value and after "Booster Delay" parameter.

Parameter	Factory Setting	Optional setting	Description
0:- 1:E 2:B 3:E+B	0	0/1/2/3	0 = No function 1 = Eco Function only 2 = Booster function only 3 = Accumulated two functions
Fct_Selection	Normal	Normal/Eco/Boost/ EcoBoost	Playback function selected in 1:Eco 2:Booster 3:ECoBoost
Eco Delay	5 min	1-30 min	Scan time before activating function if possible
Eco Hysteresis	5°C	1-20°C	Temperature range in which the function is applicable
Valve Hysteresis.	10%	0-80%	Maximum opening of the valve before switching function
Booster Delay	2 sec	2-200 sec	Time delay between the Booster functions stops and the second pump stops
Booster Gradient	2°K/s	1 to 20°K/sec	Minimum temperature fall speed at which the function operates

7.8 Fouling function

Fouling function can be activated when the sensor S3 is connected.
Accessing the fouling-menu requires login at Technician level.

If the temperature in S3 is too high for a long time this function activates an alarm that consider the heat exchanger fooled.

Parameter	Factory Default Setting	Optional setting	Description
Fouling alm activ	0	0/1	0=disabled / 1=enabled
Fouling_alarm	Normal/Default		Read only
SP_Fouling	65°C	60-80	Depends on the HE type and Primary inlet temperature

7.9 230V Triac menu

Accessing the 230C Triac-menu requires login at Technician level.

This menu allows using a 230VAC Triac output.

Parameter	Factory Default Setting	Optional setting	Description
Multi P 	Off	Off / On	Enable or Disable the 230V output as per clock program
Pulse Duration	5 sec	1-3600	230V pulse duration in seconds
Bypass 0=Off 1= ON	N/A	N/A	N/A
DeltaT Bypass	N/A	N/A	N/A

The 230V electrical output can be configured as a pulse function. For example, it can be used to shortly activate an electrical drain valve.

In this configuration, the pulse duration can be programmed to be active a day, week or special day.

For example, each Sunday at 10h00 for 5 seconds.

Connected device must not exceed 230VAC 1A.

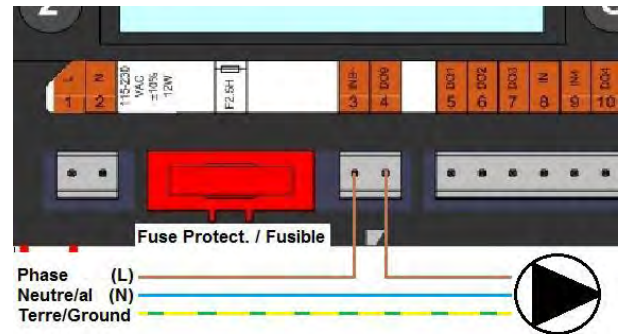

Picture 20

7.10 Pumps Menu

P1 and P2=Primary pumps

P3 and P4=Secondary pumps

Parameter	Factory Default Setting	Optional setting	Description
P1P2 Diff.work time	12 hrs	1 - 1000 hours	P1 or P2 Working time
P1P2 Cycling.Type	2	0=Fixed time 1=Fixed time+ diff.work time 2=Immediately after Diff.hrs	0 : See P12 Permut Hour
			1 : If diff reached at this time, pump shift
			2 : Don't care of permutation day+hour
P1P2 Cycling.Period	0	0=None 1=Daily 2=Weekly 3=Monthly	
P1P2 Cycling day	1	From 1st to 31st	Available only if "P12 Cycling Period" =3"
P1P2 Cycling Hour	10h00 pm	00h00 - 23h59 (11h59 pm)	Pump shift time
Min Speed P1P2	40	10->100	N/A
P1P2 Overlap	6	0-10 seconds	Time to start P2(P1) before stopping P1(P2), to let the other pump start
P3P4 Diff.work time	12 hrs	1 - 24 hours	P3 or P4 Working time
P3P4 Cycling Type	2	0=Fixed time 1=Fixed time+ diff.work time 2=Immediately after Diff.hrs	0 : See P34 Cycling Hour
			1 : If diff reached at this time, pump shift
			2 : Don't care of Cycling day+hour
P3P4 Cycling Period	0	0=None 1=Daily 2=Weekly 3=Monthly	
P3P4 Cycling day	1	From 1st to 31st	Available only if "P34 Cycling Period=3"
P3P4 Cycling Hour	10h00 pm	00h00 - 23h59 (11h59 pm)	
P3P4 Overlap	6	0-10 seconds	Time to start P4(P3) before stopping P3(P4), to let the other pump start
Pump_Fault_Reset	Off	Off/On	To clear a pump default, set to On, then Off

7.11 Autotest menu

Accessing the Autotest menu requires login at Technician level.

This submenu allows testing analog (contacts) and digital (0-10V) outputs that manage pumps start/stop, both programmable relays, 230V Triac output and valve' signal. It is possible to run an automatic sequence or to test manually each output individually.

In case of Auto test (automatic sequence), it is possible to reduce or increase tests' temporizations. Pump, valve and relays test times can be adjusted individually. The time test value will impact on the total auto test time sequence.

Parameter	Factory Setting	Optional Setting	Description
Start AutoTest	0	0/1	Set 1 to start auto test. When finished, the value goes back to zero.
Pump_Fault_Reset	Off	Off/On	Set to On after an Auto test.
Pump time test	4 sec	1-600 sec	Not used
Valve time test	4 sec	1-600 sec	Temporisations to adjust test duration.
Alarm time test	4 sec	1-600 sec	Relays 1 and 2 test
Cmd_P1	On/Off	On/Off	Activates pump 1 relay
Cmd_P2	Off/On	On/Off	Activates pump 2 relay
Speed_P1P2	xx %	0-100 %	Not used
Cmd_P3	On/Off	On/Off	Activates pump 3 relay
Cmd_P4	Off/On	On/Off	Activates pump 4 relay
Speed_P3P4	xx %	0-100 %	Not used
Relay 2	Off	On/Off	Activates relay 2
Relay 1	Off	On/Off	Activates Relay 1
Triac_Output	Off	On/Off	Activates 230V triac output
Valve signal	xx %	0-100 %	Valve opening/closing
Valve2 signal	xx %	0-100 %	N/A
Valve_DO	xx %	0-100 %	N/A



NOTE ! Once test is manually done and finished, remember to put the point on Automatic mode, logo .

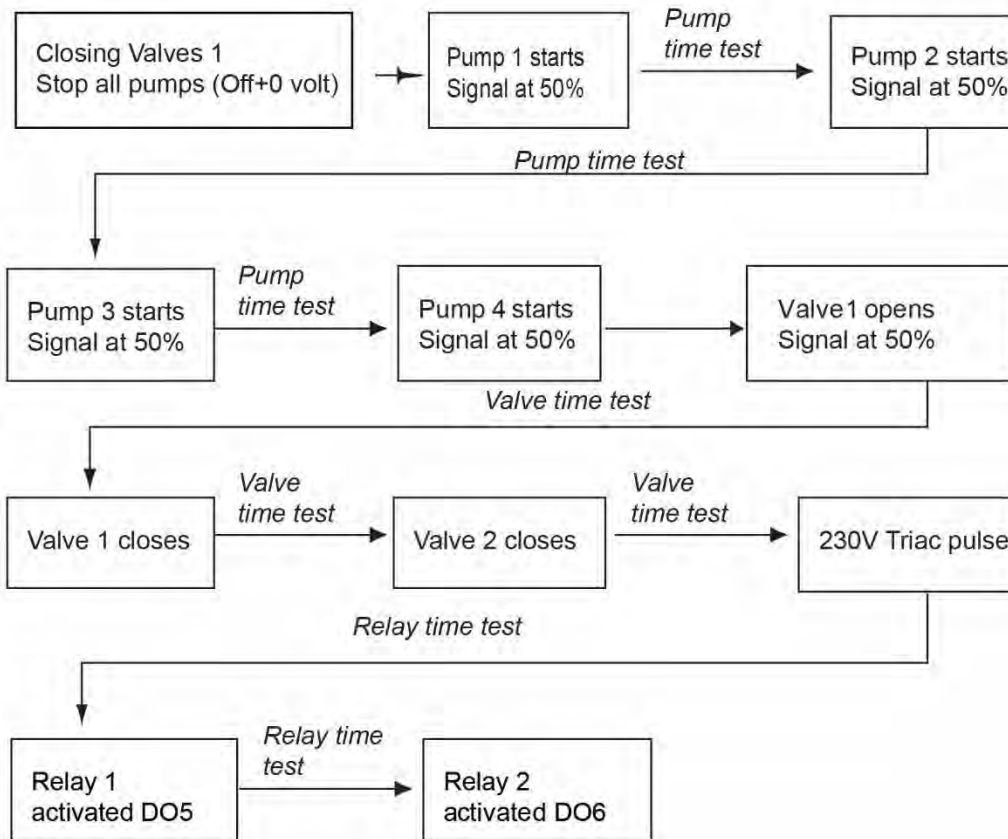

NOTE: A pump fault may occur after Auto test. In this case, clear the alarm according to [7.12 Clear alarm menu](#).

7.12 Clear alarm menu

Accessing the Clear Alarm menu requires login at Technician level.

All alarms are cleared the same way.

Parameter	Factory Default Setting	Optional Setting	Description
High_Alm_Reset	Off	Off/On	Select On to clear the alarm, then return to Off or wait a few seconds for automatic return to Off
Pump-Fault_Reset	Off	Off/On	Select On to clear the alarm, then return to Off or wait a few seconds for automatic return to Off

8 Service Menu

Press the  key to enter the Service menu. In the service menu you can:

- change password for technician level
- trending parameters
- display the trend buffer
- check operating hours.

From Point Data sub-menu you can, read or change binary or analog outputs to start/stop a pump, open/close control valve for example.

8.1 Change password for technician level

NOTE: To change the password you need the password for the Technician level, level 3.

1. Press  key to access to Service Menu, go to “Login Installer”, press the wheel.
2. Enter the current password, press the wheel to validate.

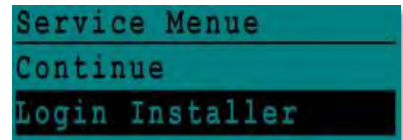

3. Mark “Change Password” then press the wheel.



4. Go to Level 3 line and then click on the password to change it. Press the wheel to validate.

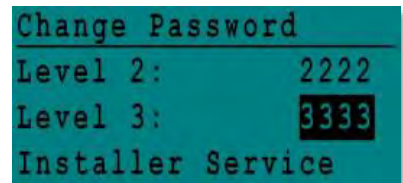

NOTE: Level 2 password is not in use.

8.2 Login installer

Login Installer	****		Enter 3333 if not in technician mode
	Change password		

8.3 Menu Continue

Menu	Sub-menu	Sub-menu	Description	
Continue	Operating hours		Viewing operating hours of internal parameters	
	Trending	Points in trend	Select variables to trend for example temperature sensors	
		Display Trend buffer	View the records	
	Interface Config (com)	C-Bus active	Factory pre-set	
		Ctr#	Factory pre-set	
		B-port 9600	Factory pre-set	
		Append bus number to data point name	Activated	
		RF Teach in (N/A)	Factory pre-set	
		Modbus	Device ID: 10 Baud Rate: 9600 Parity: None No.stop bits: 1	
	Time Program	Solar	Not used	
		Main	It is SP_T_Sec_Oulet (main temperature program). <i>See 7.4 S1 Menu Secondary Outlet.</i>	
		TSP_Amb	Not used	
		Multi Pulse	<i>See 7.9 230V Triac menu</i>	
		Therm. treatment	<i>See 7.5 Thermal Treatment Menu</i>	
	Point Data	Internal parameters +I/O visualisation		
		Analog input	Sensor values	
		Pseudo Analog	Can be set points or internal parameters	
		Analog Output	Valve output signal	
		Binary input	Ipsothermic contacts from pumps, remote contact	
		Pseudo Binary	Internal flags	
		Binary Output	Pump start/stop contacts, relays contacts, 230V Triac	
		Totalizer	N/A	
		Remote Analog	N/A	
		Remote Binary	N/A	
	System Data	System informations		
		Parameters	N/A	
		Date/Time	Clock settings	
		System Info	Hardware/Software info (version, date)	
		Interface Config	Access to Modbus parameters	
		DDC Times	Program's time constant	
		Flash memory	Info on flashing. Allows saving all settings. It can be reloaded after a Reset	

8.4 Operating hours

Operating hours for the following variables can be checked:

- Therm_Protec_P1/P2/P3/P4
- Cmd_P1/P2/P3/P4
- Main_Alarm
- High_Temp_Alarm
- ECO
- AFF_leg_active
- SAFETY_FCT
- Multi_P
- ThTr_Activated
- Booster

For more information and description see [10 Parameters list](#).

1. Press  key to access to Service Menu, then click on “Continue”.

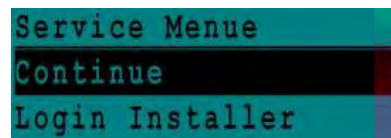

2. Select “Operating Hours” in the menu.
The first time you enter this menu, the list is empty.

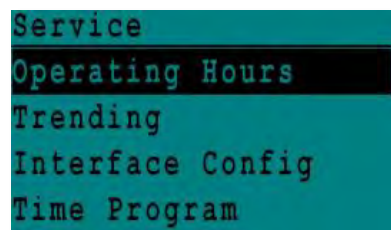

3. To add a variable to trend; choose  .

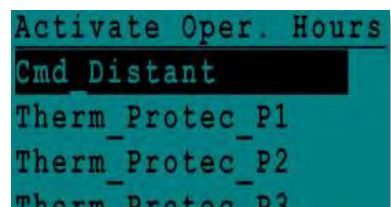

4. Mark one variable to follow and press the wheel.

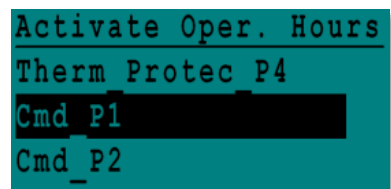

5. Validate the variable by ticking in the Operating Hours box. If this box is empty the variable is in the list but it is not recorded.

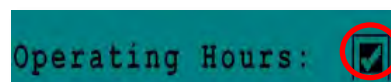

When you go back in the menu ( key), you can see the list with “Cmd_P1” parameter, and on the right side, the operating hours.

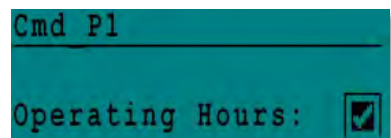

For more details, click on the line to open the sub-menu.
Here you can read that P1 has been operating less than 1 hour, has been switched one time and status is On.

Proceed the same way to add extra variables.

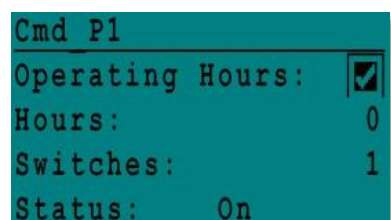

8.5 Trending parameters

A lot of different variables can be recorded or trended. It can be temperatures' measurement, valves or pumps' signals, isothermic contacts, alarms, thermal treatments etc.

1. Press  key to access to Service Menu, then click on "Continue."

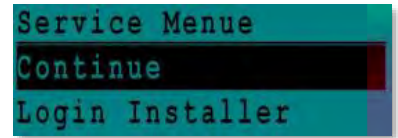

2. Select "Trending" in the menu

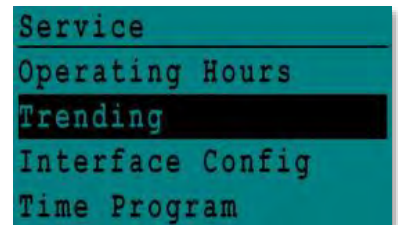

3. Select "Points in Trend".
The first time you enter this menu, the list is empty.

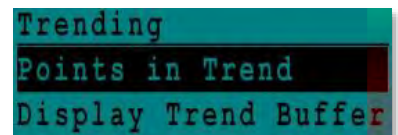

4. To add a variable to trend; choose  .

5. Mark the variable to follow and press the wheel.
In this example the Secondary outlet temperature, S1.

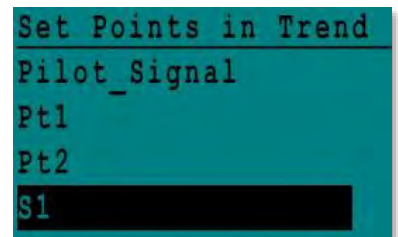

6. Validate the variable by ticking in the Trend Log box. If this box is empty the variable is in the list but it is not record.

There are two different ways to record:

- a) Only the temperature change is recorded. This saves memory and allows a longer sampling period compared to method 2.
Select the record hysteresis. In our case, every 1°C temperature change is recorded. You can change the hysteresis value by clicking on it.
- b) Record on a time base, whatever the temperature changes or not.
Note that this method consumes memory, especially if a short time base is selected. Here is the time base selected to 10 minutes recording (1 record every 10 minutes).

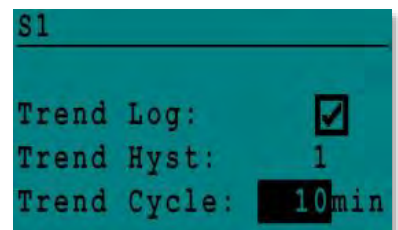
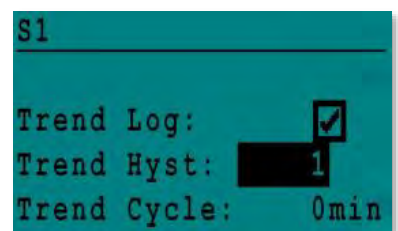

For method **a** set "Trend cycle" to zero, for method **b**, set "Trend Hyst" to zero.

8.6 Display the trend buffer

1. Press  key to access to Service Menu, then click on “Continue”.

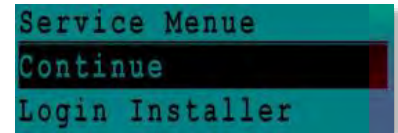

2. Select “Trending” in the menu.

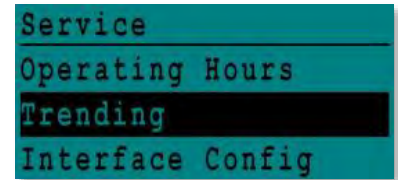

3. Select “Display Trend Buffer”.

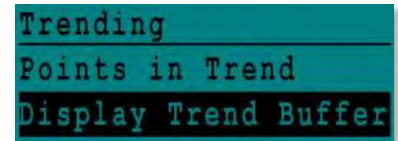

4. Select the variable to display, S1 in this case, and press the wheel.

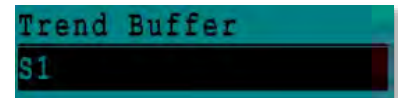

Date, time and temperature at the time can be read.
For example on 21st of September at 14h22 was the temperature in S1 58°C.

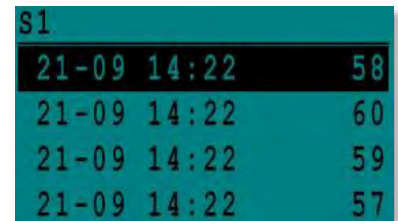

8.7 Point Data

From the menu Point Data, it is possible to start/stop a pump, open/close the control valve for example.

This menu includes

- read or change analog inputs
- read or change digital inputs
- read or write digital outputs (start and stop a pump)
- read or write analog outputs (open or close control valve for example).

NOTE ! Once test is manually done and finished, remember to put the point on Automatic mode, logo  .

9 Alarm menu

Alarm indication: Is volt Free Contacts (VFCs), 2 Amps maxi, each under 230 V.

Press  key to access to Alarm menu. The menu contains four different lists:

- **Alarm Buffer**
Lists all events with; date, time and type of event.
- **Points in Manual**
List of all points actually in manual mode this list should be empty. When point values are forced for tests for example, they should be place in automatic mode at the end.
- **Points in Alarm**
Lists all events with alarm condition.
- **Critical Alarms**
Lists all alarms with critical alarm condition.
Critical alarms are important alarms, like high temp.
- **Non-Critical Alarms**
Lists all non-critical alarm condition.
These alarms are more information, like power failure.

For example, in the alarm buffer you can read:

15:52	SAFETY_FCT
15:51	SAFETY_Speed
15:41	SAFETY_Speed
15:40	SAFETY_FCT

Note that the alarms are listed with the latest at the top.

Press a line to see more information about the alarm.

Displayed	Meaning
19-06-2012 15:52 SAFETY_FCT On Auto operation	The safety function has been set to auto mode, stopping the safety function at 15h52.
19-06-2012 15:51 SAFETY_Speed 100% Auto operation	The safety speed has been set in Auto mode at 100% at 15h51.
19-06-2012 15:41 SAFETY_Speed 75% Manual operation	The speed pump has been set manually to 75% at 15h41.
19-06-2012 15:40 SAFETY_FCT On Manual Operation	The safety function has been activated manually the 19th of June 2012 at 15h40.

10 Parameters list

There are more than 100 different variables used in the controller. Most of them are used for internal programs and calculations. Here we describe the main points.



Name	Description	Unit	Modbus Address*
Therm_Protec P1	Ipsothermic input from P1 pump	0/1	11
Therm_Protec P2	Ipsothermic input from P2 pump	0/1	12
Therm_Protec P3	Ipsothermic input from P3 pump	0/1	13
Therm_Protec P4	Ipsothermic input from P4 pump	0/1	14
PD_Cmd_P1	P1 command. It is the pump Start/Stop output	On/Off	15
PD_Cmd_P2	P2 command. It is the pump Start/Stop output	On/Off	16
PD_Cmd_P3	P3 command. It is the pump Start/Stop output	On/Off	17
PD_Cmd_P4	P4 command. It is the pump Start/Stop output	On/Off	18
PriP1_Alarm_On	Primary pump 1 default	0/1	19
PriP2_Alarm_On	Primary pump 2 default	0/1	20
Sec_P3_Fault	Secondary pump3 default	0/1	25
Sec_P4_Fault	Secondary pump4 default	0/1	26
PDMain_Alarm	General Alarm	0/1	28
High_Temp_Alarm	High temperature alarm on S1 sensor	0/1	29
Fouling_Alarm	Fouling heat exchanger Alarm	0/1	30
Ret_High_Alarm	High temperature alarm on S2	0/1	31
ThermTr_Alarm	Thermal treatment failed	0/1	32
SAFETY_FCT	The safety function state	0/1	35
Disp_Leg_active	Thermal treatment running	0/1	36
Remote_Control	The unit is remotely controlled	0/1	37
BOOSTMode	Booster function activated	0/1	41
ECOMode	ECO function activated	0/1	42
Tank_load	Tank loaded (sensor S2 need to be connected)	0/1	44
PA10_valve1	Primary valve actuator	0-100%	47
S1_10	Secondary Outlet temperature measurement (S1 sensor)	°C	50
S2_10	Secondary Inlet temperature measurement (S2 sensor if present)	°C	51
S3_10	Primary Outlet temperature measurement (S3 sensor if present)	°C	52
S1_PID_SP_10	Current temperature set point of the main control loop on S1	°C	62
High_Alm_Reset	To Reset a high temperature alarm	On/Off	201
Pump_Fault_Reset	Resets a pump fault	On/Off	202
SP_T_Sec_Outlet	Domestic Hot Water Setpoint (S1)	°C	211
ThTr_Setpoint	Thermal treatment temperature set point	°C	213
PD_Triac_Output	230V Triac output state.	On/off	33

* Please refer to “MODBUS” section in next pages.

11 Factory RESET



After a reset must the controller be configured, see [7.3 Configuration menu](#). Especially the number of pumps must be configured.

1. Press both  and  for 5 seconds.
2. Rotate the wheel; select the last line (program name with a star at the end).
3. Press the wheel a few seconds and the program will start after 1 minute.

Settings are now factory settings.

```
15-10-2012      13:41
Wiring Check
C-Bus:          
CTR#   1        19200
AL_09_2ST 12-10-12 *
```

Note that on some software versions, the displayed language can be changed.

1. Rotate the wheel clockwise to display all available languages.
2. Select and press the wheel.
3. Then, press on "Factory" line to start the controller.

If another line is available, it contains previous set parameters and function before Reset was done. You can then recover all the parameters.

```
02/07/2013      15:27
Alfa Laval Startup
C-Bus config:   
CTR#   2        38400
Select Language:
English (1)
French
```

12 Modbus

12.1 Modbus communication

The controller includes a Modbus slave communication protocol, type Modbus RTU RS485.

Connection between BMS (building management system) and Micro 3000 requires two polarized wires on C+ and C-, respectively labelled 25 and 26 on controller C Bus terminal.

The connection via shielded cable is not required but can be performed with the terminal 24. For this, it is necessary to unscrew the front panel.



Picture 21

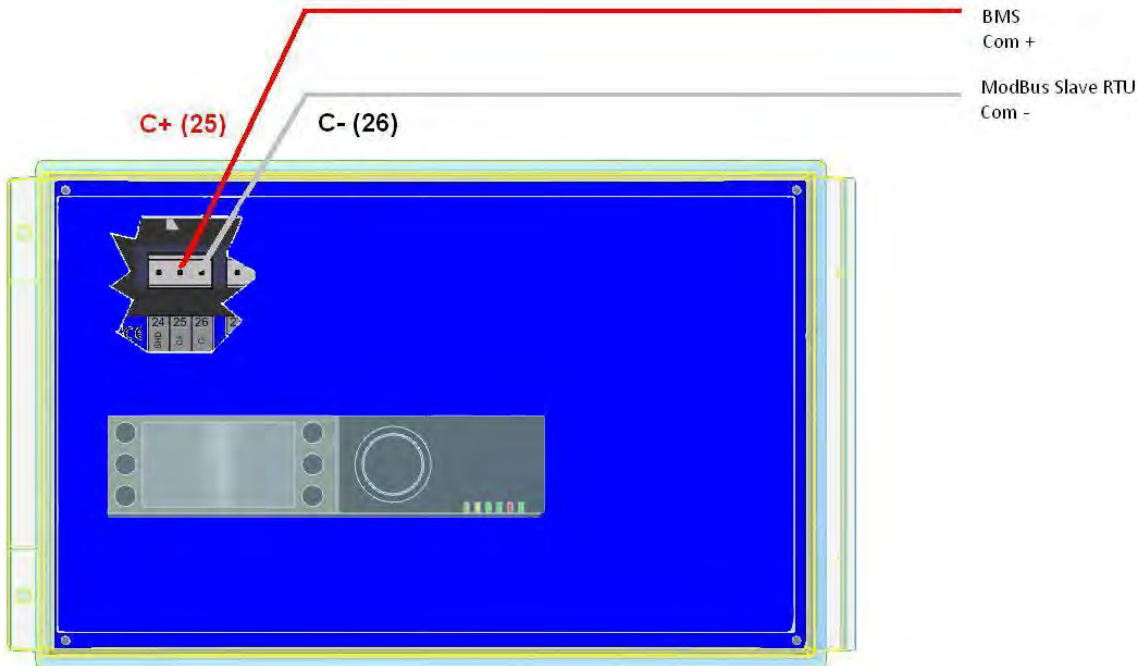

Picture 22

12.2 Connecting multiple Micro 3000 control boxes



Rules to respect

Max length between BMS and farer control box: 500 meters
 Connection continuity (C+ and C-) has to be done directly on the controller C Bus terminal, without using derivation boxes. Respecting this, there are two wires per terminal, except the farer control box.

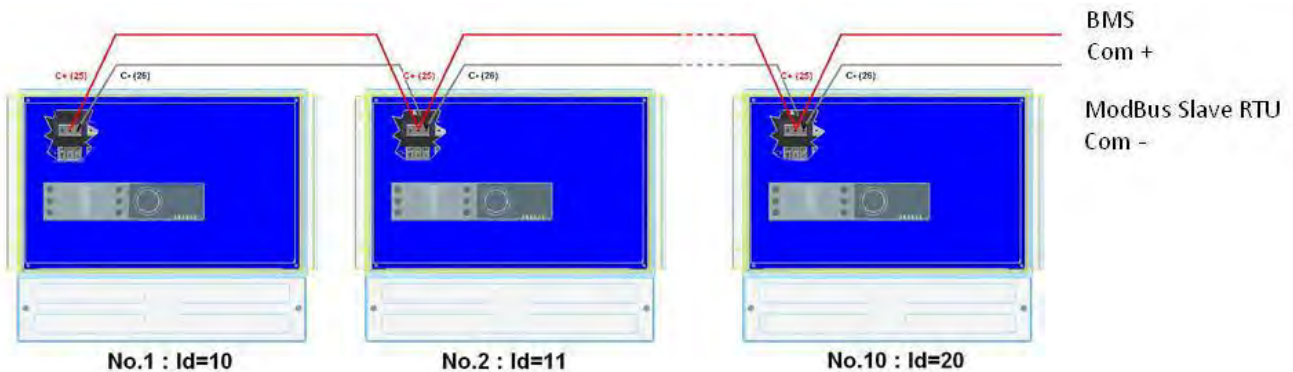

Picture 23

12.3 Change Modbus parameters

1. Press  key to access to Service Menu, go to "Login Installer", press the wheel.
2. Enter the current password, press the wheel to validate.

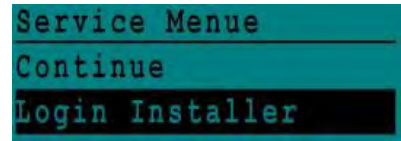

3. Mark "Next" then press the wheel.

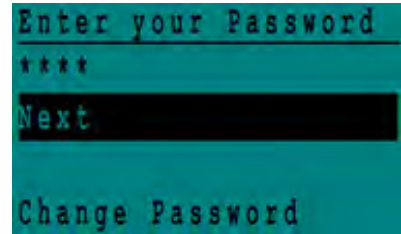

4. Select "Interface Config"

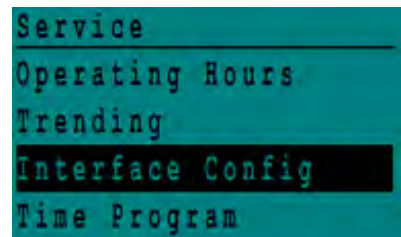

5. Select "Modbus".

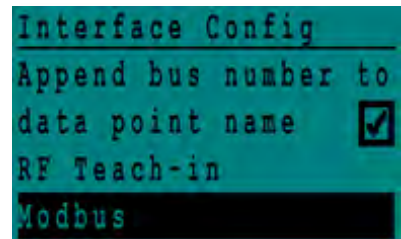

6. Select the variable to change
Press the wheel to validate.
Device ID = Modbus Address of the controller
Baud Rate=Com speed
Parity = None (0) / Even /Odd
No of Stop Bits= 0/1

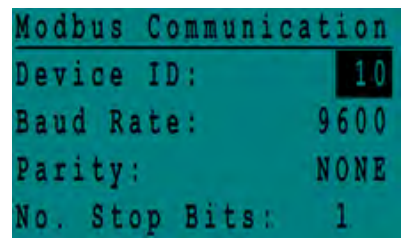

12.4 Modbus slave communication parameters

MODBUS PARAMETERS	Speed:	9600	
	Bit number:*	8	
	Stop bit:	1	
	Parity:	None	
	Mode:	RTU	

In case of multiple controllers, change ModBus slave number

ModBus Points	MODBUS address**	Type	Sub-type	Mode	Value	Comment
---------------	---------------------	------	----------	------	-------	---------

Read Only digital

PD Cmd P1	15	HR 16	BOOL	R	0=Off, 1=On	Command P1
PD Cmd P2	16	HR 16	BOOL	R	0=Off, 1=On	Command P2
PD Cmd P3	17	HR 16	BOOL	R	0=Off, 1=On	Command P3
PD Cmd P4	18	HR 16	BOOL	R	0=Off, 1=On	Command P4
PriP1 Alarm On	19	HR 16	BOOL	R	0=OK, 1=Alarm	P1 Fault
PriP2 Alarm On	20	HR 16	BOOL	R	0=OK, 1=Alarm	P2 Fault
SecP3 Alarm On	23	HR 16	BOOL	R	0=OK, 1=Alarm	P3 Fault
SecP4 Alarm On	24	HR 16	BOOL	R	0=OK, 1=Alarm	P4 Fault
PD High Alarm	27	HR 16	BOOL	R	0=OK, 1=Alarm	S1 High Temp Alarm
PDMain Alarm	28	HR 16	BOOL	R	0=OK, 1=Alarm	General default
Fouling Alarm	30	HR 16	BOOL	R	0=OK, 1=Alarm	Fouling alarm (S3)
ThermTr Alarm	32	HR 16	BOOL	R	0=OK, 1=Alarm	Therm.Treat. Failed
PD Triac Output	33	HR 16	BOOL	R	0=Off, 1=On	230V Triac output
SAFETY FCT	35	HR 16	BOOL	R	0=Off, 1=On	Safety function
Disp Leg active	36	HR 16	BOOL	R	0=Off, 1=On	Therm.Treat. On going
Remote Control Rct	37	HR 16	BOOL	R	0=Off, 1=On	Remote control
AFF FD20	39	HR 16	BOOL	R	0=Off, 1=On	Heating mode
AFF FD22	40	HR 16	BOOL	R	0=Off, 1=On	Cooling mode
BoostMode	41	HR 16	BOOL	R	0=Off, 1=On	BOOSTER active
EcoMode	42	HR 16	BOOL	R	0=Off, 1=On	ECO activated
PD Pumps Fault	43	HR 16	BOOL	R	0=Off, 1=On	Synthesis pump(s) fault
Tank load	44	HR 16	BOOL	R	0=Off, 1=On	Tank loaded

(16 bit integer/Entier 16 bit)*

Read Only Analogic

SW AL Version	34	HR 16	int16	R		Software version
PA10 valve1	47	HR 16	int16	R	%	Control valve 1 signal
S1 10	50	HR 16	int16	R	°C	Sensor 1 measurement
S2 10	51	HR 16	int16	R	°C	Sensor 2 measurement
S3 10	52	HR 16	int16	R	°C	Sensor 3 measurement
S1 PID SP 10	62	HR 16	int16	R	°C	Calculated S1 setpoint

(16 bit integer/Entier 16 bit)*

Read-Write digital

High Alm Reset	201	HR 16	BOOL	R/W	1=Reset fault. Pulse point necessary 30 seconds	On/Off
Pump fault Reset	202	HR 16	BOOL	R/W	1=Reset fault. Pulse point necessary 30 seconds	On/Off

(16 bit integer/Entier 16 bit)*

Read-Write Analogic

SP T Sec Outlet	211	HR 16	int16	R/W	°C	S1 fixed setpoint (DHW)
ThTr setpoint	213	HR 16	int16	R/W	°C	Thermal treatment setpoint

(16 bit integer/Entier 16 bit)*

* For some supervisors, it is necessary to implement BOOL as int16

** For some supervisors, remove 1 to adress number (ex : S1 10 adress=49)

*** If present

13 Trouble shooting

FINDINGS	PROBABLE CAUSES	REMEDIES
Pump not operating	Locked rotor or damaged	Force to rotate. Replace if required
	Corresponding led is not lit	Replace Power Board
	Pump relay damaged	Replace Power Board
	Pump protection fuse blown	Check then replace if necessary
	High Alarm condition detected	Clear alarm then reset system
	No voltage to control board terminals	Check power supply cable and fuses
	No voltage to pump motor terminals	Check protection fuse on main board, cable condition and connections
	Controller improperly set	Contact After Sales Service
Low temp alarm condition	Primary pump stopped	See "Pump not operating"
	Too low primary temperature	Check for a closed valve in the primary
	Too high tap water flow rate (SI)	Reduce buffer vessel charging flow rate
	Set point too high 3 way valve remains closed	See "Modulating valve does not operate"
Modulating valve does not operate	Damaged or broken actuator	Test and replace if necessary
	Broken or improperly tightened coupling	Check and replace if necessary
	Valve blocked	Replace
	No signal from the controller	Check then replace if necessary
	Supply wires improperly tightened	Check wires, re-tighten connections
	Actuator stroke restricted	Dismount then clean the valve
High alarm condition detected	Charging pump stopped (SI versions)	Refer to "Pump not operating" above
	Low recirculation flow rate (I versions)	Check and fix problem
	Alarm differential too low	Check and set the controller
	Modulating valve not closing	Refer to previous box above
	Too much differential of pressure across the modulating valve	Check the way the TWM is piped-up. Mixing arrangement should be used
	Correct temperatures across the exchanger not obtained. Valve and pumps operating satisfactorily	Excessive exchanger scaling at the primary or secondary side
Primary pipe work obstructed or strainer upstream clogged		Inspect primary pipe work. Clean strainer on the primary side
Isolation valve closed		Open isolation valves
Air presence in the primary		Purge. Check no high parts where air could be trapped exist
Excessive pressure drops		Check pipe size is suitable for nominal flow rate
Temperature does not increase in the buffer vessel and the tap water value is correct.	Recirculation flow rate exceeds charging flow rate.	Check and measure charging and recirculation flow rates. Adjust when necessary
		Recirculation FR < 0.6 x Charging FR

14 Maintenance and repairs

Cetetherm AquaFirst does not require any specific maintenance.
The frequency of the inspections depends on the water hardness, temperature and flow rate.

- Weekly inspection to check for leaks from pipes or components.
- Weekly inspection to make sure that the operation control systems is stable and that the temperature does not fluctuate. Temperature hunting causes unnecessary wear of valves, actuators.
- The control box does not require any specific maintenance; annually check the electrical connections tightening.
- Annually check the control valve that no leaks are detected.
- Regularly check lime scaling on the connected devices as scaling depends of water quality, hardness and temperatures levels.

Scaling of the secondary side will be evidenced by:

- a high pressure drop on the secondary side of the exchanger
- improper temperature range on the secondary side of the exchanger
- low temperature difference between inlet and outlet on the primary side of the exchanger when the control valve is fully open.



Only replace any defective parts with the **original** spare parts.
Please contact your Cetetherm distributor for spare parts, note serial number and model designation.



Maintenance work must be carried out by a qualified and authorized technician.



Hazard of severe electrical shock or burn.
Before cleaning and servicing, disconnect power supplies.



Risk of burns. Let the pipes cool down before starting out with maintenance work.

14.1 Open the control box

Remove the front panel by turning the lock button counter clockwise and lift the cover.



Picture 24

Unscrew the two screws in bottom and lift up the black panel.



Picture 25

14.2 Change fuses

The control box is fitted with a set of fuses to protect the different components against overload. Extra fuses are included in the control box for quick servicing.



The service work must be carried out by an authorized service technician.
Turn off the power supply before starting to work.

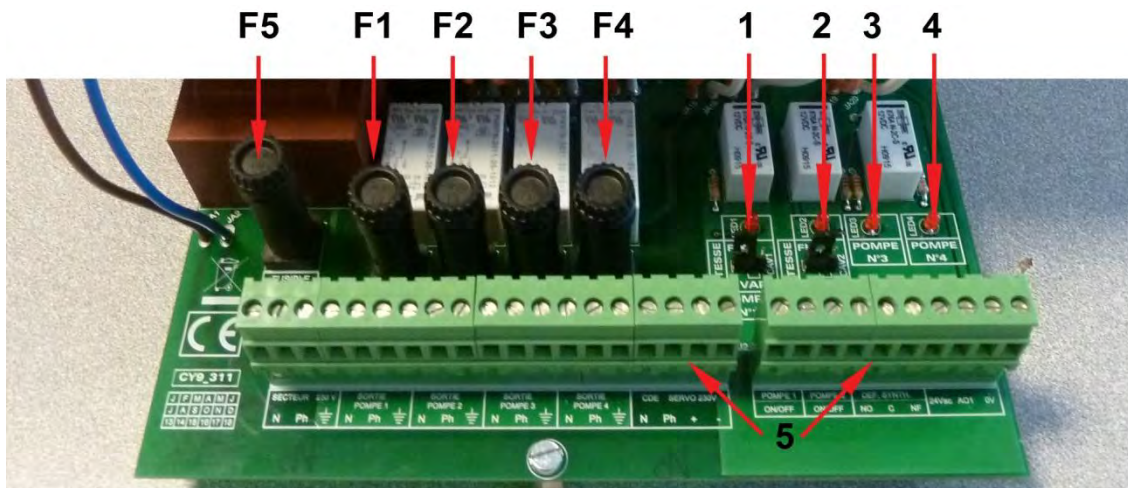

Picture 26

- F5 Fuse F5
- F1 Fuse F1
- F2 Fuse F2
- F3 Fuse F3
- F4 Fuse F4

- 1 Led 1, lit when pump P1 is power supplied
- 2 Led 2, lit when pump P2 is power supplied
- 3 Led 3, lit when pump P3 is power supplied
- 4 Led 4, lit when pump P4 is power supplied
- 5 Terminal block

Fuse	FU1	FU2	FU3	FU4	FU5
Protection	PUMP 1	PUMP 2	PUMP 3	PUMP 4	Power card
Size	6,3 x 32	6,3 x 32	6,3 x 32	6,3 x 32	6,3 x 32
Rating	2,5 A	2,5 A	2,5 A	2,5 A	800 mA
Voltage	250 V	250 V	250 V	250 V	250 V

14.3 Pumps' number

The pumps' configuration and connections is factory made. In a servicing situation the correct pump must be identified.

Codification	Meaning	Connected pump(s)
FlxxxIS	Instantaneous Single	P1
FlxxxID	Instantaneous Double	P1+P2
FlxxxSS	Semi-instantaneous Single / Single	P1+P3
FlxxxDS	Semi-instantaneous Double / Single	P1+P2+P3
FlxxxxDD	Semi-instantaneous Double / Double	P1+P2+P3+P4

14.4 Add a recycling pump to an AquaFirst Direct

A recycling pump can be added to an AquaFirst Direct. The pump must be connected to P3.

14.5 Add an extra pump

AquaFirst uses Class A constant speed pumps.

NOTE: After adding a pump, make sure that the pump selector is correctly set.

1. Open the Control Box.
2. On the right side of the printed circuit board, PCB; find the selector for the actual pump.
3. Place the pump type selector to the left, constant speed pump (●=● ●).

If lit, the corresponding pump is energized.

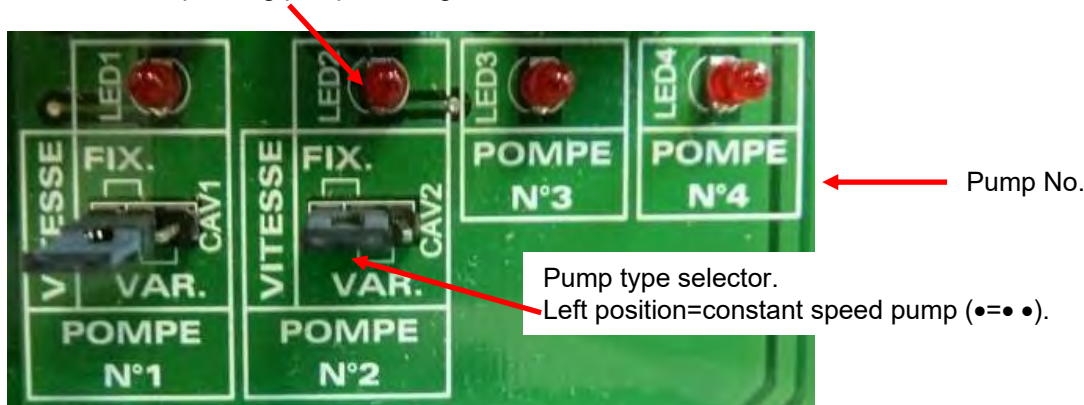

Picture 27

14.6 Primary pump wiring

14.6.1 Wirings inside pump

Description	Controller Terminal No.		Corresponding Pump's Terminal
Primary pump Isothermic contact	46 (Pump1) 47 (Pump2) *		Normally closed contact (NC)
	37 or 31 (GND)		Common contact (C)
Pump Start / Stop	N.A.		Shunt ⊥ and S/S if not already done

* As per equipment

14.6.2 Pump head setting



Rep.	Designation
1	Operating status see 14.6.3 Operating status .
2	Light fields indicating the pump setting.
3	Push-button for selection of pump setting. Press several times to set speed 3 in Zone 2, indicates with « III »
4	With a double head pump, press for 3 seconds on each push-button to disable the radio communication between the heads. To activate each motor, go to the “Autotest” sub-menu to energize the corresponding head. Once communication disabled, the central light of the pump (rep.1) must disappear.

14.6.3 Operating status

Indication on pump head	Cause	Operating status
	No electric power supply	Pump is not running
	Pump is power supplied	Pump is running
	Multiple(s)	Warning
	Multiple(s)	Alarm The pump is stopped

14.7 Add an extra sensor



Please see [4.2 Electrical wiring diagram](#).
S1-S3 are temperature sensors, NTC20k.

14.8 230V Triac output

The 230V electrical output can be configured as a pulse function. For example, it can be used to shortly activate an electrical drain valve.

In this configuration, you can program pulse duration, day, week or special days you want this to happen. For example, each Sunday at 10h00 for 5 seconds.

See [7.9 230V Triac menu](#).

Connected device must not exceed 230VAC 1A.

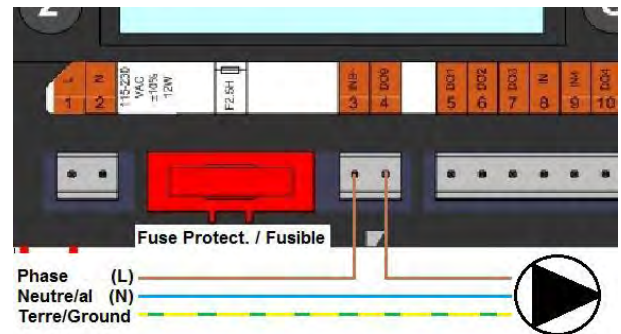

Picture 28

14.9 Relay 1 and 2 contacts

Relay 1 can be NO (normally open) or NC (normally closed).
Relay 2 is always NO (normally open).

Connect the relay 1:

Operating mode	Connections on PCB bottom terminal
NO	C-NO (25-24)
NC	C-NF (25-26)

Connect relay 2 to the controller terminal 13(IN6) and 14 (OUT6).

Cetetherm AquaFirst

Installation, service and operating instruction

See [4.2 Electrical wiring diagram](#).



If using 230V phase through this contact, do not exceed 2A load.

14.10 Remote Control contact

The AquaFirst can be operated by a remote controller. To enable that connect a volt free contact between B11 and GND.

Wire terminal name	Wire terminal number
B11	33
GND	31 or 37

See [4.2 Electrical wiring diagram](#).

NOTE: When the contact is open, the unit operates normally. If it is closed, primary and secondary pump are stopped and valves get a 0% (0 volt) signal. The unit is in standby but the controller display remains activated.

14.11 Clean plate heat exchangers

Disassembling of the exchanger can be done very quickly according to the following procedure:

1. Isolate primary and secondary hydraulic circuits.
2. Open the purge cocks to drop the internal pressure of each sides.
3. Measure the distance between the two frames of the exchanger (Plate pack thickness) and note it down.
4. Open the exchanger by unscrewing and removing the frame compression bolts.



Plates' package thickness PHE in between frames

M3H FI2000 & FI4000

N type thickness	7	17	27	45
M3H 0,5mm SS316	21,8	50,8	79,8	132,0

M6M MH/ML FI6000 & FI8000

N type thickness	11	13	17	23	31	55
M6M MH/ML 0,5mm SS316	40	47	61	82	110	194

NOTE: To avoid injuries owing to sharp edges, protective gloves should always be worn when handling plates and protective sheets (like the ones for insulation).

5. Remove the plates without damaging the gaskets and note their orientation and position.
6. Clean the plates using a soft plastic brush and water or a solution of diluted acid in accordance with PHE plate general cleaning instructions.



DO NOT USE hydrochloric acid or any acid that could corrode stainless steel plates.

DO NOT USE water with more than 330 ppm Cl when making a cleaning solution. Nitric (for calcium carbonate), sulfamic (for calcium sulphate) or citric (for silt) acids can be used. Concentration should not exceed 4% at 60°C. Protective gloves and glasses should always be worn while these operations.

Carefully rinse the plates with clean water after cleaning.

7. Remount the plates in the same order and at the same position they were before.
8. Screw the frames to the same distance they were before (Plate pack thickness dimension).
9. Clean the control sensor pocket.

14.12 Technical data

	Model 2000 & 4000	Model 6000 & 8000
Electrical data:	230V 50Hz 1-phase	230V 50Hz 1-phase
Main measurements:	Max. 485x535x970mm (LxWxH)	Max. 850x505x1315mm (LxWxH)
Weight:	70-103 kg	153-226 kg
Electric consumption, Pmax (W)	Pmax (W) 85-750* Imax (A) 1,2-5,7*	Pmax (W) 380-1440* Imax (A) 2,2-6,8*

*With Booster function activated

14.13 Spare parts-Aqua First 2000 & 4000

Only replace any defective part with the **original** spare part. Please contact your local Cetetherm agency.

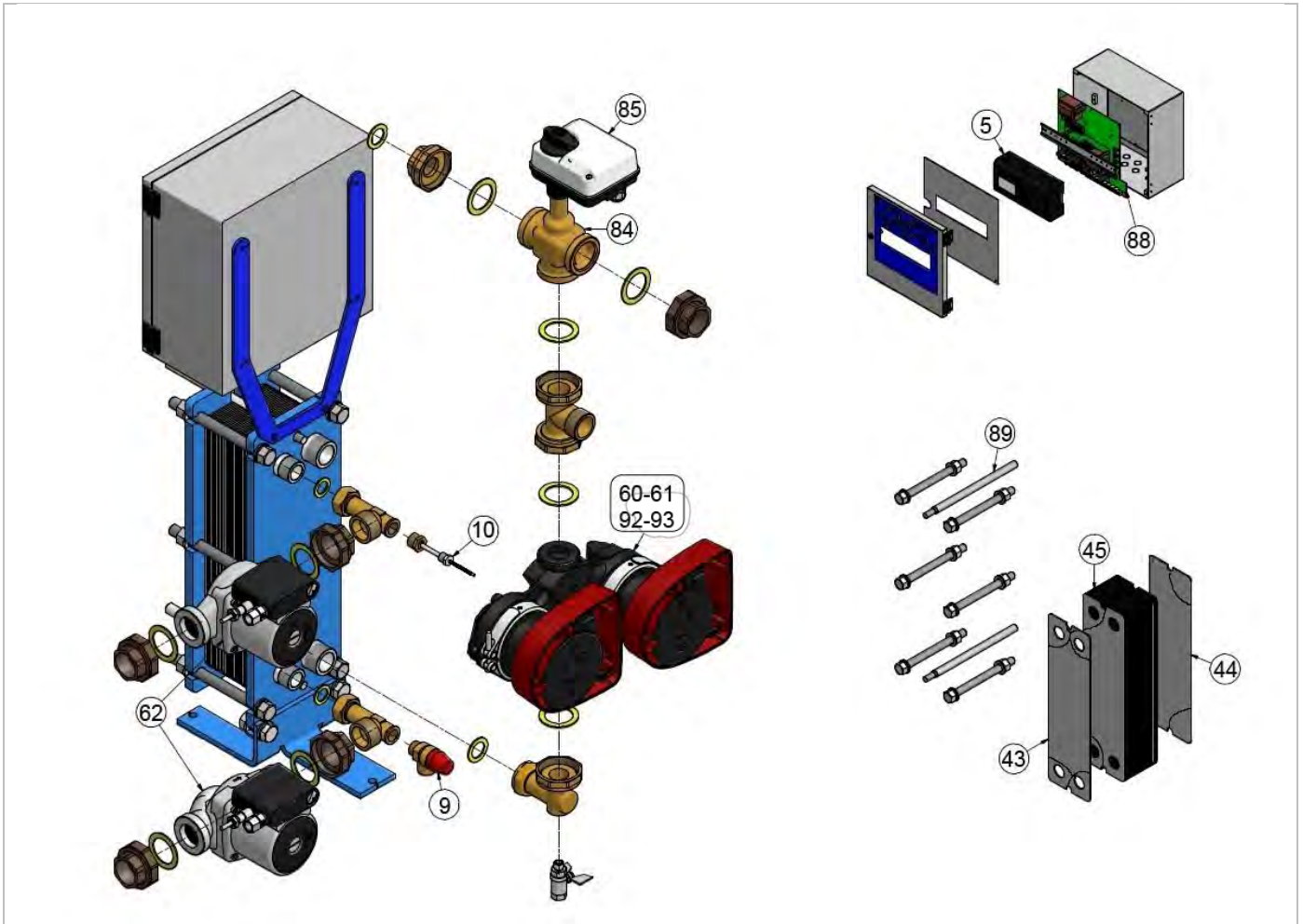

Picture 29

Position	Description Spare parts AquaFirst 2000 & 4000	Part number
5	Micro 3000 controller	REG30910
9	Safety valve - Male - DN 15 - 10 Bar	SOU29011
10	NTC20k temp sensor + 2m cable	SON30210
43	Plate - M3 H 316 - 0,5mm - EDPM 1st plate	PLAM3H316E4B
44	Plate - M3 H 316 - 0,5mm - EDPM. End plate	PLAM3H316E4F
45	Plate - M3 H 316 - 0,5mm - EDPM std plate	PLAM3H316EST
60	MAGNA1 32-40, 1*230 pump*	POM202408
61	MAGNA1 D 32-40, 1*230 pump	POM202448
62	UPS 32.80N AL 230V SS316 wired	POM2002601C
84	3 Port valve body DN32 Kvs 16	COR21261
85	Actuator ML7430E1005 0-10 Volts	MOT21272
88	ArmaFirst interface card with connectors	KITREG02
89	Set of tightening bolts AquaFirst M3	KITVIS25
92	MAGNA1 32-80, 1*230 pump*	POM202410
93	MAGNA1 D 32-80, 1*230 pump*	POM202450
	Insulation for AquaFirst M3	CALM3FI

** AquaFirst 2000 includes Magna1(D)32-40 and AquaFirst 4000 includes Magna1(D).

14.14 Spare parts Aqua First 6000 & 8000

Only replace any defective part with the **original** spare part. Please contact your local Cetetherm agency.

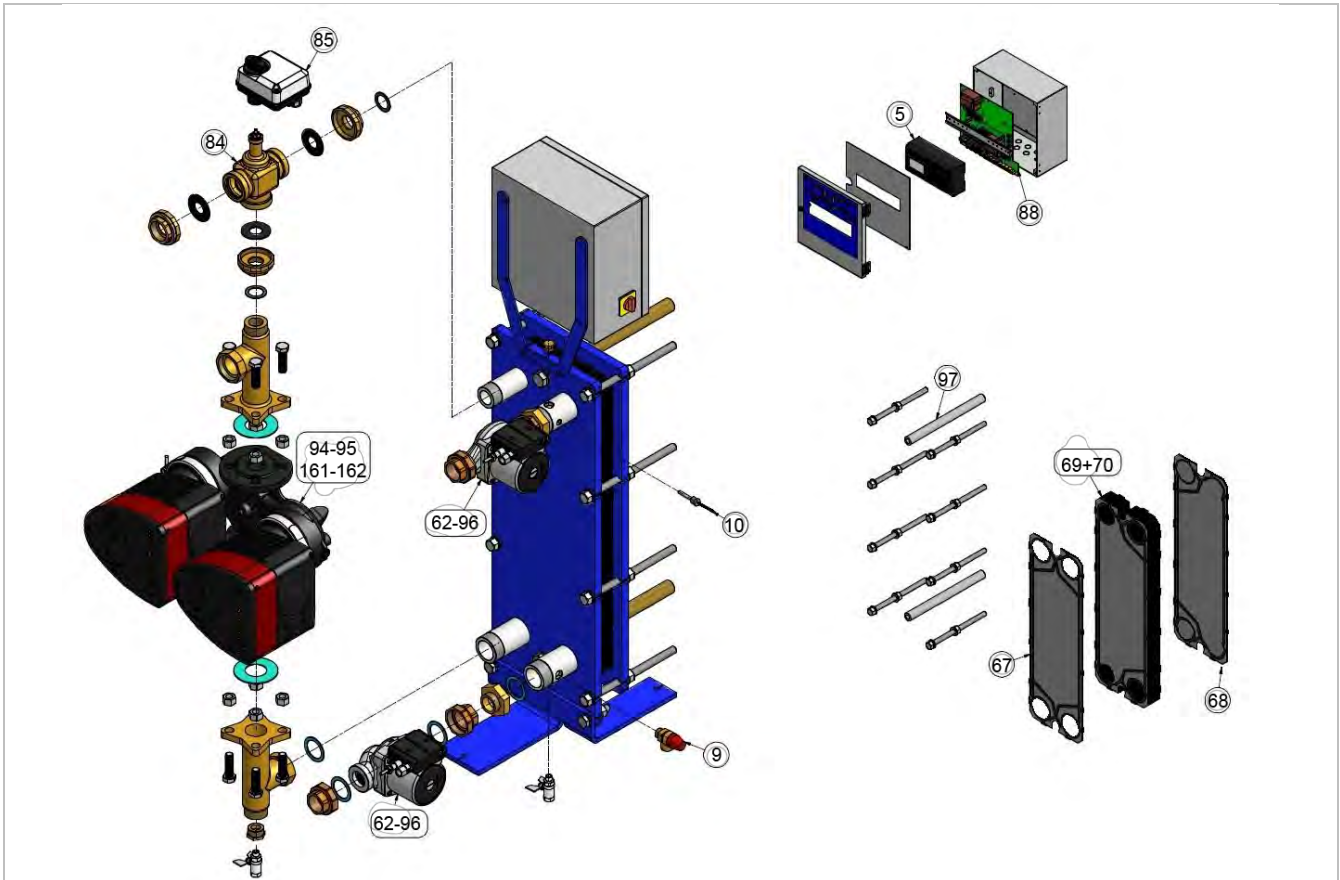

Picture 30

Position	Description Spare parts AquaFirst 6000 & 8000	Part number
5	Micro 3000 controller	REG30910
9	Safety valve - Male - DN 15 - 10 Bar	SOU29011
10	NTC20k temp sensor + 2m cable	SON30210
62	UPS 32.80N AL 230V SS316 wired for FI6000	POM2002601C
67	Plate M6M H 316 - 0,5 EPDM gasket - 1st plate	PLAM6MH316E4B
68	Plate M6M H 316 - 0,5 EPDM gasket - End plate	PLAM6MH316E4F
69	Plate M6M H 316 - 0,5 EPDM gasket - Std plate	PLAM6MH316EST
70	Plate M6M L 316 - 0,5 EPDM gasket - Std plate	PLAM6ML316EST
85	Actuator ML7430E1005 0-10 Volts	MOT21272
88	ArmaFirst interface card with connectors	KITREG02
94	MAGNA1 40-100 1*230V pump*	POM202414
95	MAGNA1 D 40-100 1*230V pump*	POM202454
96	UPS 32.100N IMU 230V SS316 wired for FI8000	POM200262C
97	Set of tightening bolts AquaFirst M6	KITVIS30
98	3 Port valve body DN40 Kvs 25	COR21262
161	MAGNA1 40-60 1*230V pump*	POM2024136
162	MAGNA1 D 40-60 1*230V pump*	POM202453
	Insulation for AquaFirst M6	CALM6FI

* AquaFirst 6000 includes Magna1(D)40-60 and AquaFirst 8000 includes Magna1(D)40-100.

15 Commissioning report

COMMISSIONING REPORT			
Installation			
Tightening dimension control			
Air vent position			
Settling Pot presence on primary			
Boiler Brend, installation and power			
Mixing bottle required / Presence			
Balancing valve presence on Indirect (Semi Instantaneous) installations			
Close drain valves			
Primary conformity:			
Secondary conformity:			
Accessibility of unit and components			
Configuration menu			
Sensors			
Pumps			
Other			
Primary Pumps:	Secondary Pumps:		
Pump 1		Pump 2	
Pump 3		Pump 4	
Electrical bridges control for pumps on power plate			
Pump 1		Pump 2	
Pump 3		Pump 4	
Control valve working			
Settings			
DHW secondary outlet T° setting: S1			
PID setting			
High alarm setting		Manual	
Thermal Treatment		Setting	
Eco function activation			
Booster function activation			
Other functions activated			
Relay 1 function			
Relay 2 function			
Trending and/or Modbus value activated			
Volt free Remote contact wired or not			
TRIAC 230 V connections wired or not			
Other comments:			
Identification of the unit:			
Unit ID N°	Installer / Company Name	Installation site	Date

16 Declaration of conformity

PED 2014/68/EU art 4.3, LVD, EMC, RoHS

Declaration of Conformity
Déclaration de conformité
Konformitätserklärung
Conformiteitsverklaring



Manufacturer / Fabricant / Hersteller / Fabrikant

Cetetherm SAS

Route du Stade ZI du Moulin, FR 69490 Pontcharra sur Turdine, France

- * Heat exchanger unit, District heating System, for heating and/or Domestic Hot Water
- * Échangeur thermique, système de chauffage urbain, pour le chauffage et l'eau chaude sanitaire
- * Fernwärme-Kompaktstationen, für Heizung und/oder Trinkwarmwasser
- * Warmtewisselaarunit, stadsverwarmingsysteem, voor verwarmingswater en/of sanitair warm water

Products/ Produits/ Produkte/ Producten	Models/ Modèles /Varianten/ Modellen
Cetetherm AquaFirst	Honeywell/Samson/Grundfos/Wilo

Above mentioned products are in article 4.3 according to PED 2014/68/EU
Les produits susmentionnés figurent à l'article 4.3 conformément à la DESP 2014/68/EU
Vorstehend benannte Produkte fallen unter Artikel 4.3 der DGRL 2014/68/EU
Bovengenoemde producten zijn conform artikel 4.3 van Richtlijn 2014/68/EU (Richtlijn Drukapparatuur)

Used directives/ Directives utilisées/ Angewendete Direktiv/ Gebruikte richtlijnen

- PED 2014/68/EU
- LVD 2014/35/EU
- EMC 2014/30/EU
- RoHS 2011/65/EU

Used other standards and specifications/ Autres normes et spécifications utilisées/ Weitere angewendete Standards/ Andere gebruikte standaarden en specificaties

- EN 60335-1 partly/ EN 60335-1 en partie/ EN 60335-1 teilweise/ EN 60335-1 gedeeltelijk
- EN 60204-1 partly/ EN 60204-1 en partie/ EN 60204-1 teilweise/ EN 60204-1 gedeeltelijk

Conformity Assessment procedure:
Procédure d'évaluation de conformité :
Konformitätsbewertungsverfahren:
Conformiteitsbeoordelingsprocedure:

Sound Engineering practice
Règles de l'art
Gute Ingenieurpraxis
Regels van goed vakmanschap



Pontcharra sur Turdine, 01-06--2018
Matthieu Perrin

Product manager/ Responsable de la conformité/ Bevollmächtigter/ Verantwoordelijke voor conformiteit/

17 Warranty

Our equipment comes with a 12-month warranty from the date of shipment. This may be extended to 6 months from the date of commissioning of the equipment, subject to commissioning report being mailed to Cetetherm.

The warranty period is limited to 18 months from the actual date of shipment from the factory.

The manufacturer's liability is limited to the replacement of any defective part that cannot be repaired. No other financial compensation may be claimed in any case under the warranty

The nature and probable cause of the defect must be reported to the manufacturer before any action is taken. The defective part should then be returned to our factory in France for assessment unless written agreement to proceed otherwise has been obtained from Cetetherm. The results of the assessment can only state whether the terms of the warranty apply.

Exclusion factors:

Non-compliance with the guidelines for installation, configuration and maintenance:
Over pressures, water-hammer, scaling, noncompliant water quality

Also excluded from the warranty:

- Fitting costs, refitting costs, packaging, transport, and any accessories or equipment not manufactured by Cetetherm, which will only be covered by any warranties issued by said third-party manufacturers.
- Any damage caused by connection errors, insufficient protection, misapplication or faulty or careless operations.
- Equipment disassembled or repaired by any other party than Cetetherm.

Non-payment will lead to all operational warranties covering the delivered equipment being terminated.

17.1 How to contact Cetetherm

Our contact details are updated on our website www.cetetherm.com.

Cetetherm sas
ZI du Moulin, Route du Stade
69490 Pontcharra sur Turdine - France
www.cetetherm.com

Cetetherm

The logo for Cetetherm features the company name in a bold, black, sans-serif font. Below the text is a solid green horizontal bar that tapers to the right, creating a dynamic, forward-pointing shape.